



2019 CONTRACTOR BOOKLET

Northland Steel Manufacturing Plant

9262 93rd Ave. S.E.

Fullerton, North Dakota 58441

phone: 701-375-4470

toll-free: 877-862-4571

toll-free fax: 866-678-2823

fax: 701-375-4471

orders@northlandsteelandtrim.com

Joel Assid

Garretson, South Dakota

phone: 605-201-5635

email: joel.assid@outlook.com

Pat Heintzman

Fargo, North Dakota

phone: 701-799-4067

email: heintzmanp@aol.com

Jim Grueneich

Jamestown, ND

phone: 701-535-0286

email: jimgrueneich@yahoo.com

www.northlandsteelandtrim.com

Northland

Steel & Trim

2019

Phone 877-862-4571

Weekly Delivery Schedule

Fax 866-678-2823

Monday Delivery		Wednesday		Friday Delivery	
Orders submitted by the previous Thursday at 5:00 pm		Orders submitted by the previous Friday at 5:00 pm		Orders submitted by the previous Tuesday at 9:00 A:M	
North Dakota	Minnesota	North Dakota	South Dakota	South Dakota	Minnesota
Casselton	Ada	Anamoose	Aberdeen	Plankinton	Adrian
Cooperstown	Alexandria	Ashley	Arlington	Platte	Beaver Creek
Drayton	Appleton	Beach	Avon	Redfield	Brewster
Enderlin	Argyle	Beulah	Beresford	Roscoe	Clements
Fairmount	Ashby	Bismarck	Bowdle	Salem	Comfrey
Fargo	Barnesville	Bottineau	Brookings	Sioux Falls	Edgerton
Finley	Benson	Bowman	Bryant	Stickney	Fairmont
Forman	Canby	Cando	Canova	Timber lake	Fulda
Grafton	Chokio	Carrington	Canton	Tripp	Hendricks
Grand Forks	Clara City	Carson	Chamberlain	Vermillion	Heron Lake
Gwinner	Crookston	Crosby	Clark	Wagner	Jackson
Hillsboro	Danube	Devils Lake	Colman	Wessington	Jasper
Hope	Dawson	Dickinson	Colton	Wessington Springs	Lake Benton
Langdon	Detroit Lakes	Dunseith	Corsica	Willow Lake	Lake Benton
Lidgerwood	Elbow Lake	Elgin	Dell Rapids	Woonsocket	Lakefield
Lisbon	Evansville	Esmond	Desmet	Yankton	Lamberton
Mayville	Fergus Falls	Flasher	Dimock	Wilmont	Leota
McVile	Fertile	Garrison	Elkton		Lismore
Page	Frazee	Glen Ullin	Estelline		Luverne
Tolna	Glenwood	Golva	Ethan		Marshall
Valley City	Gonvick	Harvey	Eureka		Minneota
Wahpeton	Granite Falls	Hazelton	Fairfax		Morgan
Wimbledon	Greenbush	Hazen	Faulton		Pipestone
	Gully	Hettinger	Fort Pierre	Iowa	Redwood Falls
	Hawley	Jamestown	Gettysburg	Boyden	Sanborn
South Dakota	Hazel Run	Kenmare	Gregory	Cherokee	St.James
Bristol	Hector	Killdeer	Hartford	Doon	Tracy
Britton	Henning	Linton	Herreid	Estherville	Truman
Caselwood	Herman	Minot	Highmore	George	Wabasso
Clear Lake	Hoffman	Mott	Howard	Hartley	Windom
Eden	Hendricks	Napoleon	Humboldt	Hawarden	Worthington
Groton	Miltona	New Rockford	Huron	Hospers	
Holmquist	Morris	New Salem	Ipswich	Inwood	
Langford	Osakis	New Town	Kimball	Larchwood	
Milbank	Oslo	Parshall	Lake Andes	Little Rock	
Peever	Ottertail	Powers Lake	Lake Norden	Ocheyedan	
Rosholt	Park Rapids	Rolla	Leola	Orange City	
Sisseton	Parkers Prairie	Rugby	Lesterville	Paullina	
Watertown	Pelican Rapids	Stanley	Madison	Primghar	
Webster	Perham	Strasburg	Marion	Rock Rapids	
Wilmot	Red Lake Falls	Tappen	Menno	Rock Valley	
	Sauk Center	Underwood	Miller	Sanborn	
	Stephen	Washburn	Mitchell	Sheldon	
	Thief River Falls	Watford City	Mobridge	Sibley	
	Ulen	Williston	Onida	Sioux Center	
	Vergas	Wishek	Parker	Spencer	
	Wabon		Parkston	Sutherland	
	Wadena		Pierre		
	Willmar		Peever		

INDEX

Page

D-rib = A-Panel = Pro- Max = Panel-Rib & Dr!pStop Barn Master.....	1-2-3-4-5-6
Soffit Panels D-Rib & A-Panel	7
MWI Soffit	8
Trims	9-10-11-12-13-14-15-16-17
Door Hardware = Flashers = Nutseter & Door Locks.....	20
Side Rail = Bottom Rail = “H” Rail & Square Track	23
Walk Doors & Window Lites.....	21
Windows = Ridgevents = Cupolas = Insulation & Butyl Tape.....	22
Screws & Rivets	18-19
R-Panel & R-Panel Dr!pStop	24-25
R-Panel Trims	26-27-28
Classic Snap Lock = NLS Snap Lock & Trim	31-32-33
Roll Valley = Fashing = Roof Edge = Silicone = Marvec Liner	29-30 & 34
<u>1 to 4 sheets will be at customers risk when shipping</u>	

CARE & HANDLING

Storage

Galvanized steel sheets have a good service life when exposed to normal weather conditions. However, these sheets are subject to stain when water sits upon or becomes trapped between the sheets.

If galvanized sheet are to be stored for any period of time, they should be unbundled and stood on end against an interior wall. Metal should be spread or fanned out at their bottom ends to allow for air circulation and should be off the ground on blocks. If storage is to be for a day or two, keep the metal inside inside in the bundle up off the ground on blocks. Never cover the material with plastic as this promotes sweating. Failure to follow these steps may result in wet storage stain and premature white rusting, which the manufacturer cannot be held responsible for.

Cutting

When using a power saw to cut metal panels several precautions should be taken. Place the bottom {interior} surface of the sheets up and cover with a tarp to protect the top {exterior} surface from the hot metal filings and reduce the chance of damage. When doing the actual cutting, be sure to wear protective eye glasses and do it away from other unused or applied panels. Metal filings may become embedded in the surface of the sheet and if left alone will quickly rust. Be sure to wipe all filling from both surfaces before application

RETURNS

There will be no Returns Accepted without a Return Memo and there will a 30% Restocking charge. Material must be wrapped and in saleable condition
No Returns after 60 days. Job cut steel will not be available to Return.

Item #
(29GA)

Page 1

Item #
(26GA)

DB10 {29ga}	D-rib Galvanized		DB60 {26ga}
DB11 {29ga}	D-rib White		DB61 {26ga}
DB12 {29ga}	D-rib Green		DB62 {26ga}
DB13 {29ga}	D-rib Lightstone		DB63 {26ga}
DB14 {29ga}	D-rib Taupe		DB64 {26ga}
DB15 {29ga}	D-rib Ash Gray		DB65 {26ga}
DB16 {29ga}	D-rib Ocean Blue		DB66 {26ga}
DB17 {29ga}	D-rib Tan		DB67 {26ga}
DB18 {29ga}	D-rib Charcoal Gray		DB68 {26ga}
DB19 {29ga}	D-rib Red		DB69 {26ga}
DB20 {29ga}	D-rib Brown		DB70 {26ga}
DB21 {29ga}	D-rib Black		DB71 {26ga}
DB22 {29ga}	D-rib Burgundy		DB72 {26ga}
DB23 {29ga}	D-rib Bone Wht		DB73 {26ga}
DB24 {29ga}	D-rib Antique Bronze		DB74 {26ga}
DB25 {29ga}	D-rib Hess Green		DB75 {26ga}
DB26 {29ga}	D-rib Brite Red		DB76 {26ga}
DB27 {29ga}	D-rib Dark Blue		DB77 {26ga}
DB28 {29ga}	D-rib Pewter Gray		DB78 {26ga}
DB29 {29ga}	D-rib Copper Penny		DB79 {26ga}
DB32 {29ga}	D-rib Covert Green		DB82 {26ga}
DB33 {29ga}	D-rib Shale Green		DB83 {26ga}
DB38 {29ga}	D-rib Liner Panel White		DB88 {26ga}
DB36 {29ga}	D-rib Perforated		DB39 {26ga}

DB30	D-rib {26ga} Diamond Embossed Aluminum Bare	call
DB31	D-rib {26ga} Aluminum White Alloy 3105 Tamper H24	call

DB98	D-rib - 12' Fiberglass Skylite
DB48	D-rib - 12' Poly Carb Clear Panel
DB49	D-rib - 16' Poly Carb Clear Panel

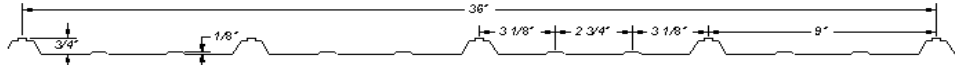

Cutting Charge under 48" (per cut)

Closures & Profile Vents

DB90	D-rib - Large Outside Closures
DB91	D-rib - Small Inside Closures
VV85	10' VersaVent Profile 1.28 per min
DB85	D-rib - Low Profile Vent 16.9 sq. inches per Linear Foot at the ridge
US10	1"x1" Uniseal 20' roll
	26ga 4' X 10' 6" (per sq ft)

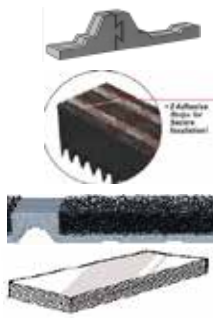

Item #
(29GA)

Page 2

Item #
(26GA)



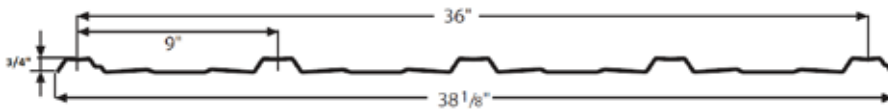

AP10 {29ga}	A-Panel Galvanized		AP60 {26ga}
AP11 {29ga}	A-Panel White		AP61 {26ga}
AP12 {29ga}	A-Panel Green		AP62 {26ga}
AP13 {29ga}	A-Panel Lightstone		AP63 {26ga}
AP14 {29ga}	A-Panel Taupe		AP64 {26ga}
AP15 {29ga}	A-Panel Ash Gray		AP65 {26ga}
AP16 {29ga}	A-Panel Ocean Blue		AP66 {26ga}
AP17 {29ga}	A-Panel Tan		AP67 {26ga}
AP18 {29ga}	A-Panel Charcoal Gray		AP68 {26ga}
AP19 {29ga}	A-Panel Red		AP69 {26ga}
AP20 {29ga}	A-Panel Brown		AP70 {26ga}
AP21 {29ga}	A-Panel Black		AP71 {26ga}
AP22 {29ga}	A-Panel Burgundy		AP72 {26ga}
AP23 {29ga}	A-Panel Bone Wht		AP73 {26ga}
AP24 {29ga}	A-Panel Antique Bronze		AP74 {26ga}
AP25 {29ga}	A-Panel Hess Green		AP75 {26ga}
AP26 {29ga}	A-Panel Brite Red		AP76 {26ga}
AP27 {29ga}	A-Panel Dark Blue		AP77 {26ga}
AP28 {29ga}	A-Panel Pewter Gray		AP78 {26ga}
AP29 {29ga}	A-Panel Copper Penny		AP79 {26ga}
AP32 {29ga}	A-Panel Covert Green		AP82 {26ga}
AP33 {29ga}	A-Panel Shale Green		AP83 {26ga}
AP38 {29ga}	A-Panel Liner Panel White		AP88 {26ga}
AP36 {29ga}	A-Panel Perforated		AP39 {26ga}

AP30	A-Panel {26ga} Diamond Embossed Aluminum Bare	call
AP31	A-Panel {26ga} Aluminum White Alloy 3105 Tamper H24	call
AP48	A-Panel - 12' Poly-Carp Clear Panel	
AP98	A-Panel - 12' Fiberglass Skylite	



Cutting Charge under 48" (per cut)

Closures & Profile Vents

AP90	A-Panel - Large Outside Closures	
AP91	A-Panel - Small Inside Closures	
VV85	10' VersaVent Profile 1.28 per min	
AP85	A-Panel - Low Profile Vent	
US10	1"x1" Uniseal 20' roll	
	26ga 4' X 10' 6" (per sq ft)	



Item #
(29GA)

Page 3

Item #
(26GA)



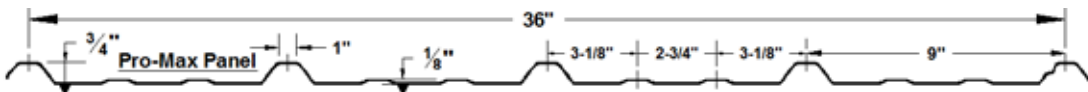

PM10 {29ga}	Pro-Max Galvanized		PM60 {26ga}
PM11 {29ga}	Pro-Max White		PM61 {26ga}
PM12 {29ga}	Pro-Max Green		PM62 {26ga}
PM13 {29ga}	Pro-Max Lightstone		PM63 {26ga}
PM14 {29ga}	Pro-Max Taupe		PM64 {26ga}
PM15 {29ga}	Pro-Max Ash Gray		PM65 {26ga}
PM16 {29ga}	Pro-Max Ocean Blue		PM66 {26ga}
PM17 {29ga}	Pro-Max Tan		PM67 {26ga}
PM18 {29ga}	Pro-Max Charcoal Gray		PM68 {26ga}
PM19 {29ga}	Pro-Max Red		PM69 {26ga}
PM20 {29ga}	Pro-Max Brown		PM70 {26ga}
PM21 {29ga}	Pro-Max Black		PM71 {26ga}
PM22 {29ga}	Pro-Max Burgundy		PM72 {26ga}
PM23 {29ga}	Pro-Max Bone Wht		PM73 {26ga}
PM24 {29ga}	Pro-Max Antique Bronze		PM74 {26ga}
PM25 {29ga}	Pro-Max Hess Green		PM75 {26ga}
PM26 {29ga}	Pro-Max Brite Red		PM76 {26ga}
PM27 {29ga}	Pro-Max Dark Blue		PM77 {26ga}
PM28 {29ga}	Pro-Max Pewter Gray		PM78 {26ga}
PM29 {29ga}	Pro-Max Copper Penny		PM79 {26ga}
PM32 {29ga}	Pro-Max Covert Green		PM82 {26ga}
PM33 {29ga}	Pro-Max Shale Green		PM83 {26ga}
PM38 {29ga}	Pro-Max Liner Panel White		PM88 {26ga}
PM36 {29ga}	Pro-Max Perforated		PM39 {26ga}
AP30	Pro-Max {26ga} Diamond Embossed Aluminum Bare	call	
AP31	Pro-Max {26ga} Aluminum White Alloy 3105 Tamper H24	call	

PM48	Pro-Max 12' Poly-Carp Clear Panel	
PM98	Pro-Max - 12' Fiberglass Skylite	



Cutting Charge under 48" (per cut)

Closures & Profile Vents

PM90	Pro-Max - Large Outside Closures	
PM91	Pro-Max - Small Inside Closures	
VV85	10' VersaVent Profile 1.28 per min	
PM85	Pro-Max - Low Profile Vent	
US10	1"x1" Uniseal 20' roll	
	26ga 4' X 10' 6" (per sq ft)	



Item		29 Gauge	
PD10	{29ga} Panel-Rib Galvanized		
PD11	{29ga} Panel-Rib White		
PD12	{29ga} Panel-Rib Green		
PD13	{29ga} Panel-Rib Lightstone		
PD14	{29ga} Panel-Rib Taupe		
PD15	{29ga} Panel-Rib Ash Gray		
PD16	{29ga} Panel-Rib Ocean Blue	Available	33" Coverage
PD17	{29ga} Panel-Rib Tan		
PD18	{29ga} Panel-Rib Charcoal Gray		
PD19	{29ga} Panel-Rib Red		
PD20	{29ga} Panel-Rib Brown		
PD21	{29ga} Panel-Rib Black	Available	33" Coverage
PD22	{29ga} Panel-Rib Burgundy		
PD23	{29ga} Panel-Rib Bone Wht	Available	33" Coverage
PD24	{29ga} Panel-Rib Antique Bronze		
PD25	{29ga} Panel-Rib Hess Green	Available	33" Coverage
PD26	{29ga} Panel-Rib Brite Red	Available	33" Coverage
PD27	{29ga} Panel-Rib Dark Blue	Available	33" Coverage
PD28	{29ga} Panel-Rib Pewter Gray		
PD29	{29ga} Panel-Rib Copper Penny	Available	33" Coverage
PD32	{29ga} Panel-Rib Covert Green	Available	33" Coverage
PD33	{29ga} Panel-Rib Shale Green	Available	33" Coverage

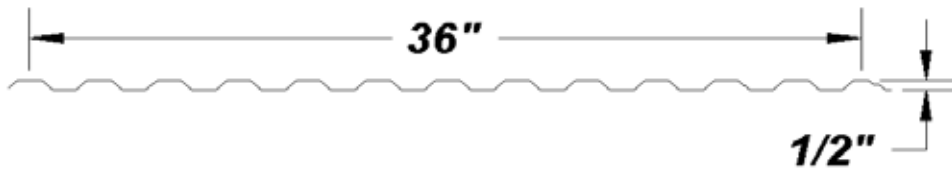

- PD98 12' Panel-rib Fiberglass Skylite
- PD96 12' Panel-rib Poly Carb Clear Panel

New in Stock

Closures

- PD90 Panel-rib Closures



Profile Vent

- VV85 10' VersaVent Profile

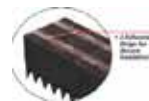

- US10 1"x1" Uniseal 20' roll



Cutting Charge under 48" (per cut)



Item #			Item #
ID10	(29ga)	D-Rib Dr!pStop Galvanized	ID60 (26ga)
ID11	(29ga)	D-Rib Dr!pStop White	ID61 (26ga)
ID12	(29ga)	D-Rib Dr!pStop Green	ID62 (26ga)
ID13	(29ga)	D-Rib Dr!pStop Lightstone	ID63 (26ga)
ID14	(29ga)	D-Rib Dr!pStop Taupe	ID64 (26ga)
ID15	(29ga)	D-Rib Dr!pStop Ash Gray	ID65 (26ga)
ID16	(29ga)	D-Rib Dr!pStop Ocean Blue	ID66 (26ga)
ID17	(29ga)	D-Rib Dr!pStop Tan	ID67 (26ga)
ID18	(29ga)	D-Rib Dr!pStop Charcoal Gray	ID68 (26ga)
ID19	(29ga)	D-Rib Dr!pStop Red	ID69 (26ga)
ID20	(29ga)	D-Rib Dr!pStop Brown	ID70 (26ga)
ID21	(29ga)	D-Rib Dr!pStop Black	ID71 (26ga)
ID22	(29ga)	D-Rib Dr!pStop Burgundy	ID72 (26ga)
ID23	(29ga)	D-Rib Dr!pStop Bone Wht	ID73 (26ga)
ID24	(29ga)	D-Rib Dr!pStop Antique Bronze	ID74 (26ga)
ID25	(29ga)	D-Rib Dr!pStop Hess Green	ID75 (26ga)
ID26	(29ga)	D-Rib Dr!pStop Brite Red	ID76 (26ga)
ID27	(29ga)	D-Rib Dr!pStop Dark Blue	ID77 (26ga)
ID28	(29ga)	D-Rib Dr!pStop Pewter Gray	ID78 (26ga)
ID29	(29ga)	D-Rib Dr!pStop Copper Penny	ID79 (26ga)
ID32	(29ga)	D-Rib Dr!pStop Covert Green	ID82 (26ga)
ID33	(29ga)	D-Rib Dr!pStop Shale Green	ID83 (26ga)

D-Rib Dr!pStop

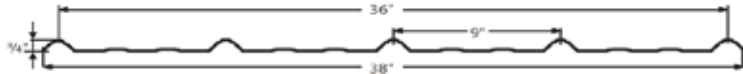

Item #			Item #
OX10	(29ga)	Pro-Max Dr!pStop Galvanized	OX60 (26ga)
OX11	(29ga)	Pro-Max Dr!pStop White	OX61 (26ga)
OX12	(29ga)	Pro-Max Dr!pStop Green	OX62 (26ga)
OX13	(29ga)	Pro-Max Dr!pStop Lightstone	OX63 (26ga)
OX14	(29ga)	Pro-Max Dr!pStop Taupe	OX64 (26ga)
OX15	(29ga)	Pro-Max Dr!pStop Ash Gray	OX65 (26ga)
OX16	(29ga)	Pro-Max Dr!pStop Ocean Blue	OX66 (26ga)
OX17	(29ga)	Pro-Max Dr!pStop Tan	OX67 (26ga)
OX18	(29ga)	Pro-Max Dr!pStop Charcoal Gray	OX68 (26ga)
OX19	(29ga)	Pro-Max Dr!pStop Red	OX69 (26ga)
OX20	(29ga)	Pro-Max Dr!pStop Brown	OX70 (26ga)
OX21	(29ga)	Pro-Max Dr!pStop Black	OX71 (26ga)
OX22	(29ga)	Pro-Max Dr!pStop Burgundy	OX72 (26ga)
OX23	(29ga)	Pro-Max Dr!pStop Bone Wht	OX73 (26ga)
OX24	(29ga)	Pro-Max Dr!pStop Antique Bronze	OX74 (26ga)
OX25	(29ga)	Pro-Max Dr!pStop Hess Green	OX75 (26ga)
OX26	(29ga)	Pro-Max Dr!pStop Brite Red	OX76 (26ga)
OX27	(29ga)	Pro-Max Dr!pStop Dark Blue	OX77 (26ga)
OX28	(29ga)	Pro-Max Dr!pStop Pewter Gray	OX78 (26ga)
OX29	(29ga)	Pro-Max Dr!pStop Copper Penny	OX79 (26ga)
OX32	(29ga)	Pro-Max Dr!pStop Covert Green	OX82 (26ga)
OX33	(29ga)	Pro-Max Dr!pStop Shale Green	OX83 (26ga)

Pro-Max Dr!pStop

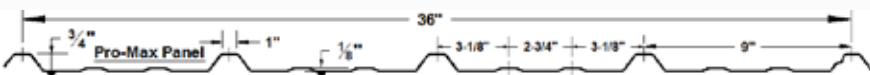



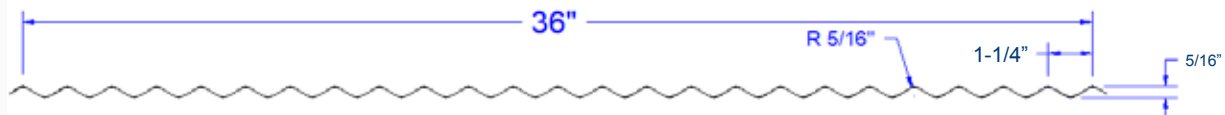

(29GA)		
BT10 {29ga}	Barn-Master Galvanized	
BT11 {29ga}	Barn-Master White	
BT12 {29ga}	Barn-Master Green	
BT13 {29ga}	Barn-Master Lightstone	
BT14 {29ga}	Barn-Master Taupe	
BT15 {29ga}	Barn-Master Ash Gray	
BT16 {29ga}	Barn-Master Ocean Blue	Available in 33" Coverage
BT17 {29ga}	Barn-Master Tan	
BT18 {29ga}	Barn-Master Charcoal Gray	
BT19 {29ga}	Barn-Master Red	Available in 33" Coverage
BT20 {29ga}	Barn-Master Brown	
BT21 {29ga}	Barn-Master Black	Available in 33" Coverage
BT22 {29ga}	Barn-Master Burgundy	
BT23 {29ga}	Barn-Master Bone Wht	Available in 33" Coverage
BT24 {29ga}	Barn-Master Antique Bronze	
BT25 {29ga}	Barn-Master Hess Green	Available in 33" Coverage
BT26 {29ga}	Barn-Master Brite Red	Available in 33" Coverage
BT27 {29ga}	Barn-Master Dark Blue	Available in 33" Coverage
BT28 {29ga}	Barn-Master Pewter Gray	
BT29 {29ga}	Barn-Master Copper Penny	Available in 33" Coverage
BT32 {29ga}	Barn-Master Covert Green	Available in 33" Coverage
BT33 {29ga}	Barn-Master Shale Green	Available in 33" Coverage

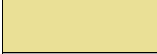
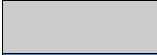

Vent soffit D-Rib & A-Panel

per lin 1" per sq. ft per lin ft

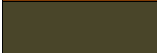
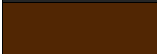
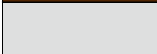
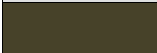
SP11	## x 36" Soffit Panel White	
SP12	## x 36" Soffit Panel Green	
SP13	## x 36" Soffit Panel Lightstone	
SP14	## x 36" Soffit Panel Taupe	
SP15	## x 36" Soffit Panel Ash Gray	
SP16	## x 36" Soffit Panel Ocean Blue	
SP17	## x 36" Soffit Panel Tan	
SP18	## x 36" Soffit Panel Charcoal Gray	
SP19	## x 36" Soffit Panel Red	
SP20	## x 36" Soffit Panel Brown	
SP21	## x 36" Soffit Panel Black	
SP22	## x 36" Soffit Panel Burgundy	
SP23	## x 36" Soffit Panel Bone Wht	
SP24	## x 36" Soffit Panel Antique Bronze	
SP27	## x 36" Soffit Panel Dark Blue	
SP28	## x 36" Soffit Panel Pewter Gray	

See Page 1 for solid soffit D-Rib

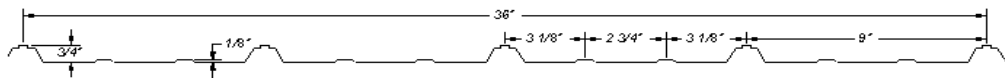

See Page 2 for solid soffit A-Panel

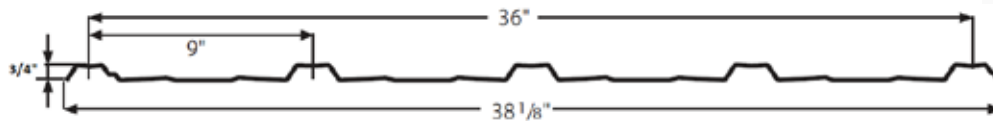

14 sq in per sq ft opening

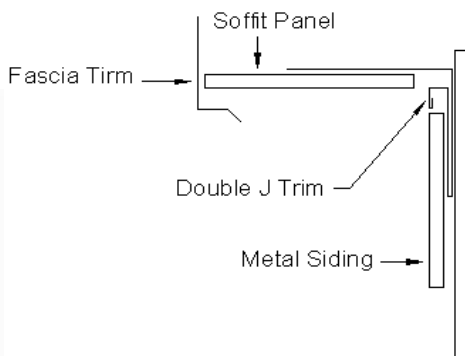

Aluminum Soffit & Trim Systems

Sold per carton only

Center vent soffit 7.5 sq in per ft		Solid soffit		3/8" Soffit Divider
VF11	5 - 24" x 16" Vented Soffit White	SS11	5 - 24" x 16" Solid Soffit White	See Page 16
VF12	5 - 24" x 16" Vented Soffit Green	SS12	5 - 24" x 16" Solid Soffit Green	
VF13	5 - 24" x 16" Vented Soffit Lightstone	SS13	5 - 24" x 16" Solid Soffit Lightstone	
VF14	5 - 24" x 16" Vented Soffit Taupe	SS14	5 - 24" x 16" Solid Soffit Taupe	
VF15	5 - 24" x 16" Vented Soffit Ash Gray	SS15	5 - 24" x 16" Solid Soffit Ash Gray	
VF16	5 - 24" x 16" Vented Soffit Ocean Blue	SS16	5 - 24" x 16" Solid Soffit Ocean Blue	
VF17	5 - 24" x 16" Vented Soffit Tan	SS17	5 - 24" x 16" Solid Soffit Tan	
VF18	5 - 24" x 16" Vented Soffit Charcoal Gray	SS18	5 - 24" x 16" Solid Soffit Charcoal Gray	
VF19	5 - 24" x 16" Vented Soffit Red	SS19	5 - 24" x 16" Solid Soffit Red	
VF20	5 - 24" x 16" Vented Soffit Brown	SS20	5 - 24" x 16" Solid Soffit Brown	
VF21	5 - 24" x 16" Vented Soffit Black	SS21	5 - 24" x 16" Solid Soffit Black	
VF22	5 - 24" x 16" Vented Soffit Burgundy	SS22	5 - 24" x 16" Solid Soffit Burgundy	
VF23	5 - 24" x 16" Vented Soffit Bone Wht	SS23	5 - 24" x 16" Solid Soffit Bone Wht	
VF24	5 - 24" x 16" Vented Soffit Antique Bronze	SS24	5 - 24" x 16" Solid Soffit Antique Bronze	
VF26	5 - 24" x 16" Vented Soffit Brite Red	SS26	5 - 24" x 16" Solid Soffit Brite Red	
VF27	5 - 24" x 16" Vented Soffit Dark Blue	SS27	5 - 24" x 16" Solid Soffit Dark Blue	
VF28	5 - 24" x 16" Vented Soffit Pewter Gray	SS28	5 - 24" x 16" Solid Soffit Pewter Gray	
VF29	5 - 24" x 16" Vented Soffit Copper Penny	SS29	5 - 24" x 16" Solid Soffit Copper Penny	
Center vent soffit		Solid soffit		3/8" Soffit F Channel
VF41	15 - 24" x 16" Vented Soffit White	SS41	15 - 24" x 16" Solid Soffit White	See Page 16
VF42	15 - 24" x 16" Vented Soffit Green	SS42	15 - 24" x 16" Solid Soffit Green	
VF43	15 - 24" x 16" Vented Soffit Lightstone	SS43	15 - 24" x 16" Solid Soffit Lightstone	
VF44	15 - 24" x 16" Vented Soffit Taupe	SS44	15 - 24" x 16" Solid Soffit Taupe	
VF45	15 - 24" x 16" Vented Soffit Ash Gray	SS45	15 - 24" x 16" Solid Soffit Ash Gray	
VF46	15 - 24" x 16" Vented Soffit Ocean Blue	SS46	15 - 24" x 16" Solid Soffit Ocean Blue	
VF47	15 - 24" x 16" Vented Soffit Tan	SS47	15 - 24" x 16" Solid Soffit Tan	
VF48	15 - 24" x 16" Vented Soffit Charcoal Gray	SS48	15 - 24" x 16" Solid Soffit Charcoal Gray	
VF49	15 - 24" x 16" Vented Soffit Red	SS49	15 - 24" x 16" Solid Soffit Red	
VF50	15 - 24" x 16" Vented Soffit Brown	SS50	15 - 24" x 16" Solid Soffit Brown	
VF51	15 - 24" x 16" Vented Soffit Black	SS51	15 - 24" x 16" Solid Soffit Black	
VF52	15 - 24" x 16" Vented Soffit Burgundy	SS52	15 - 24" x 16" Solid Soffit Burgundy	
VF53	15 - 24" x 16" Vented Soffit Bone Wht	SS53	15 - 24" x 16" Solid Soffit Bone Wht	
VF54	15 - 24" x 16" Vented Soffit Antique Bronze	SS54	15 - 24" x 16" Solid Soffit Antique Bronze	
VF56	15 - 24" x 16" Vented Soffit Brite Red	SS56	15 - 24" x 16" Solid Soffit Brite Red	
VF57	15 - 24" x 16" Vented Soffit Dark Blue	SS57	15 - 24" x 16" Solid Soffit Dark Blue	
VF58	15 - 24" x 16" Vented Soffit Pewter Gray	SS58	15 - 24" x 16" Solid Soffit Pewter Gray	
VF59	15 - 24" x 16" Vented Soffit Copper Penny	SS59	15 - 24" x 16" Solid Soffit Copper Penny	
Center vent soffit		Solid soffit		Fascia Trim
VF61	12 - 144" x 16" Vented Soffit White	SS61	12 - 144" x 16" Solid Soffit White	See Page 10
VF62	12 - 144" x 16" Vented Soffit Green	SS62	12 - 144" x 16" Solid Soffit Green	
VF63	12 - 144" x 16" Vented Soffit Lightstone	SS63	12 - 144" x 16" Solid Soffit Lightstone	
VF64	12 - 144" x 16" Vented Soffit Taupe	SS64	12 - 144" x 16" Solid Soffit Taupe	
VF65	12 - 144" x 16" Vented Soffit Ash Gray	SS65	12 - 144" x 16" Solid Soffit Ash Gray	
VF66	12 - 144" x 16" Vented Soffit Ocean Blue	SS66	12 - 144" x 16" Solid Soffit Ocean Blue	
VF67	12 - 144" x 16" Vented Soffit Tan	SS67	12 - 144" x 16" Solid Soffit Tan	
VF68	12 - 144" x 16" Vented Soffit Charcoal Gray	SS68	12 - 144" x 16" Solid Soffit Charcoal Gray	
VF69	12 - 144" x 16" Vented Soffit Red	SS69	12 - 144" x 16" Solid Soffit Red	
VF70	12 - 144" x 16" Vented Soffit Brown	SS70	12 - 144" x 16" Solid Soffit Brown	
VF71	12 - 144" x 16" Vented Soffit Black	SS71	12 - 144" x 16" Solid Soffit Black	
VF72	12 - 144" x 16" Vented Soffit Burgundy	SS72	12 - 144" x 16" Solid Soffit Burgundy	
VF73	12 - 144" x 16" Vented Soffit Bone Wht	SS73	12 - 144" x 16" Solid Soffit Bone Wht	
VF74	12 - 144" x 16" Vented Soffit Antique Bronze	SS74	12 - 144" x 16" Solid Soffit Antique Bronze	
VF76	12 - 144" x 16" Vented Soffit Brite Red	SS76	12 - 144" x 16" Solid Soffit Brite Red	
VF77	12 - 144" x 16" Vented Soffit Dark Blue	SS77	12 - 144" x 16" Solid Soffit Dark Blue	
VF78	12 - 144" x 16" Vented Soffit Pewter Gray	SS78	12 - 144" x 16" Solid Soffit Pewter Gray	
VF79	12 - 144" x 16" Vented Soffit Copper Penny	SS79	12 - 144" x 16" Solid Soffit Copper Penny	
Center vent soffit		Solid soffit		Double J Trim
VF81	6 - 144" x 16" Vented Soffit White	SS81	6 - 144" x 16" Solid Soffit White	See Page 11
VF82	6 - 144" x 16" Vented Soffit Green	SS82	6 - 144" x 16" Solid Soffit Green	
VF83	6 - 144" x 16" Vented Soffit Lightstone	SS83	6 - 144" x 16" Solid Soffit Lightstone	
VF84	6 - 144" x 16" Vented Soffit Taupe	SS84	6 - 144" x 16" Solid Soffit Taupe	
VF85	6 - 144" x 16" Vented Soffit Ash Gray	SS85	6 - 144" x 16" Solid Soffit Ash Gray	
VF86	6 - 144" x 16" Vented Soffit Ocean Blue	SS86	6 - 144" x 16" Solid Soffit Ocean Blue	
VF87	6 - 144" x 16" Vented Soffit Tan	SS87	6 - 144" x 16" Solid Soffit Tan	
VF88	6 - 144" x 16" Vented Soffit Charcoal Gray	SS88	6 - 144" x 16" Solid Soffit Charcoal Gray	
VF89	6 - 144" x 16" Vented Soffit Red	SS89	6 - 144" x 16" Solid Soffit Red	
VF90	6 - 144" x 16" Vented Soffit Brown	SS90	6 - 144" x 16" Solid Soffit Brown	
VF91	6 - 144" x 16" Vented Soffit Black	SS91	6 - 144" x 16" Solid Soffit Black	
VF92	6 - 144" x 16" Vented Soffit Burgundy	SS92	6 - 144" x 16" Solid Soffit Burgundy	
VF93	6 - 144" x 16" Vented Soffit Bone Wht	SS93	6 - 144" x 16" Solid Soffit Bone Wht	
VF94	6 - 144" x 16" Vented Soffit Antique Bronze	SS94	6 - 144" x 16" Solid Soffit Antique Bronze	
VF96	6 - 144" x 16" Vented Soffit Brite Red	SS96	6 - 144" x 16" Solid Soffit Brite Red	
VF97	6 - 144" x 16" Vented Soffit Dark Blue	SS97	6 - 144" x 16" Solid Soffit Dark Blue	
VF98	6 - 144" x 16" Vented Soffit Pewter Gray	SS98	6 - 144" x 16" Solid Soffit Pewter Gray	
VF99	6 - 144" x 16" Vented Soffit Copper Penny	SS99	6 - 144" x 16" Solid Soffit Copper Penny	

Soffit Nails 1-1/4" Ring Shank Stainless Steel

10' 6"	12' 6"	14' 6"	16' 6"		7-1/2" Door Jamb Trim
DJT10	DJT40	DJT60	DJT80	Galv	
DJT11	DJT41	DJT61	DJT81	White	
DJT12	DJT42	DJT62	DJT82	Green	
DJT13	DJT43	DJT63	DJT83	Lightstone	
DJT14	DJT44	DJT64	DJT84	Taupe	
DJT15	DJT45	DJT65	DJT85	Ash Gray	
DJT16	DJT46	DJT66	DJT86	Ocean Blue	
DJT17	DJT47	DJT67	DJT87	Tan	
DJT18	DJT48	DJT68	DJT88	Charcoal Gray	
DJT19	DJT49	DJT69	DJT89	Red	
DJT20	DJT50	DJT70	DJT90	Brown	
DJT21	DJT51	DJT71	DJT91	Black	
DJT22	DJT52	DJT72	DJT92	Burgundy	
DJT23	DJT53	DJT73	DJT93	Bone Wht	
DJT24	DJT54	DJT74	DJT94	Antique Bronze	
DJT25	DJT55	DJT75	DJT95	Hess Green	
DJT26	DJT56	DJT76	DJT96	Brite Red	
DJT27	DJT57	DJT77	DJT97	Dark Blue	
DJT28	DJT58	DJT78	DJT98	Pewter Gray	
DJT29	DJT59	DJT79	DJT99	Copper Penny	
DJT32	DJT34	DJT36	DJT100	Covert Green	
DJT33	DJT35	DJT37	DJT101	Shale Green	

10' 6"	12' 6"	14' 6"	16' 6"		9" Door Jamb Trim
DJT210	DJT240	DJT260	DJT280	Galv	
DJT211	DJT241	DJT261	DJT281	White	
DJT212	DJT242	DJT262	DJT282	Green	
DJT213	DJT243	DJT263	DJT283	Lightstone	
DJT214	DJT244	DJT264	DJT284	Taupe	
DJT215	DJT245	DJT265	DJT285	Ash Gray	
DJT216	DJT246	DJT266	DJT286	Ocean Blue	
DJT217	DJT247	DJT267	DJT287	Tan	
DJT218	DJT248	DJT268	DJT288	Charcoal Gray	
DJT219	DJT249	DJT269	DJT289	Red	
DJT220	DJT250	DJT270	DJT290	Brown	
DJT221	DJT251	DJT271	DJT291	Black	
DJT222	DJT252	DJT272	DJT292	Burgundy	
DJT223	DJT253	DJT273	DJT293	Bone Wht	
DJT224	DJT254	DJT274	DJT294	Antique Bronze	
DJT225	DJT255	DJT275	DJT295	Hess Green	
DJT226	DJT256	DJT276	DJT296	Brite Red	
DJT227	DJT257	DJT277	DJT297	Dark Blue	
DJT228	DJT258	DJT278	DJT298	Pewter Gray	
DJT229	DJT259	DJT279	DJT299	Copper Penny	
DJT232	DJT234	DJT236	DJT300	Covert Green	
DJT233	DJT235	DJT237	DJT301	Shale Green	

10' 6"	12' 6"	14' 6"	16' 6"		7" Door Trim
DT10	DT40	DT60	DT80	Galv	
DT11	DT41	DT61	DT81	White	
DT12	DT42	DT62	DT82	Green	
DT13	DT43	DT63	DT83	Lightstone	
DT14	DT44	DT64	DT84	Taupe	
DT15	DT45	DT65	DT85	Ash Gray	
DT16	DT46	DT66	DT86	Ocean Blue	
DT17	DT47	DT67	DT87	Tan	
DT18	DT48	DT68	DT88	Charcoal Gray	
DT19	DT49	DT69	DT89	Red	
DT20	DT50	DT70	DT90	Brown	
DT21	DT51	DT71	DT91	Black	
DT22	DT52	DT72	DT92	Burgundy	
DT23	DT53	DT73	DT93	Bone Wht	
DT24	DT54	DT74	DT94	Antique Bronze	
DT25	DT55	DT75	DT95	Hess Green	
DT26	DT56	DT76	DT96	Brite Red	
DT27	DT57	DT77	DT97	Dark Blue	
DT28	DT58	DT78	DT98	Pewter Gray	
DT29	DT59	DT79	DT99	Copper Penny	
DT32	DT34	DT36	DT38	Covert Green	
DT33	DT35	DT37	DT39	Shale Green	

10' 6"	12' 6"	14' 6"	16' 6"		9" Door Trim
DT100	DT140	DT160	DT180	Galv	
DT101	DT141	DT161	DT181	White	
DT102	DT142	DT162	DT182	Green	
DT103	DT143	DT163	DT183	Lightstone	
DT104	DT144	DT164	DT184	Taupe	
DT105	DT145	DT165	DT185	Ash Gray	
DT106	DT146	DT166	DT186	Ocean Blue	
DT107	DT147	DT167	DT187	Tan	
DT108	DT148	DT168	DT188	Charcoal Gray	
DT109	DT149	DT169	DT189	Red	
DT110	DT150	DT170	DT190	Brown	
DT111	DT151	DT171	DT191	Black	
DT112	DT152	DT172	DT192	Burgundy	
DT113	DT153	DT173	DT193	Bone Wht	
DT114	DT154	DT174	DT194	Antique Bronze	
DT115	DT155	DT175	DT195	Hess Green	
DT116	DT156	DT176	DT196	Brite Red	
DT117	DT157	DT177	DT197	Dark Blue	
DT118	DT158	DT178	DT198	Pewter Gray	
DT119	DT159	DT179	DT199	Copper Penny	
DT120	DT122	DT124	DT200	Covert Green	
DT121	DT123	DT125	DT201	Shale Green	

10' 6"	12' 6"	14' 6"	16' 6"	5-1/2" x 5-1/2" Rake & Corner
RAK10	RAK40	RAK60	RAK80	Galv
RAK11	RAK41	RAK61	RAK81	White
RAK12	RAK42	RAK62	RAK82	Green
RAK13	RAK43	RAK63	RAK83	Lightstone
RAK14	RAK44	RAK64	RAK84	Taupe
RAK15	RAK45	RAK65	RAK85	Ash Gray
RAK16	RAK46	RAK66	RAK86	Ocean Blue
RAK17	RAK47	RAK67	RAK87	Tan
RAK18	RAK48	RAK68	RAK88	Charcoal Gray
RAK19	RAK49	RAK69	RAK89	Red
RAK20	RAK50	RAK70	RAK90	Brown
RAK21	RAK51	RAK71	RAK91	Black
RAK22	RAK52	RAK72	RAK92	Burgundy
RAK23	RAK53	RAK73	RAK93	Bone Wht
RAK24	RAK54	RAK74	RAK94	Antique Bronze
RAK25	RAK55	RAK75	RAK95	Hess Green
RAK26	RAK56	RAK76	RAK96	Brite Red
RAK27	RAK57	RAK77	RAK97	Dark Blue
RAK28	RAK58	RAK78	RAK98	Pewter Gray
RAK29	RAK59	RAK79	RAK99	Copper Penny
RAK32	RAK34	RAK36	RAK38	Covert Green
RAK33	RAK35	RAK37	RAK39	Shale Green

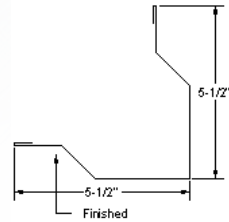

18' 6"	5-1/2" x 5-1/2" Rake & Corner
RAK100	Galv
RAK101	White
RAK102	Green
RAK103	Lightstone
RAK104	Taupe
RAK105	Ash Gray
RAK106	Ocean Blue
RAK107	Tan
RAK108	Charcoal Gray
RAK109	Red
RAK110	Brown
RAK111	Black
RAK112	Burgundy
RAK113	Bone Wht
RAK114	Antique Bronze
RAK115	Hess Green
RAK116	Brite Red
RAK117	Dark Blue
RAK118	Pewter Gray
RAK119	Copper Penny
RAK120	Covert Green
RAK121	Shale Green

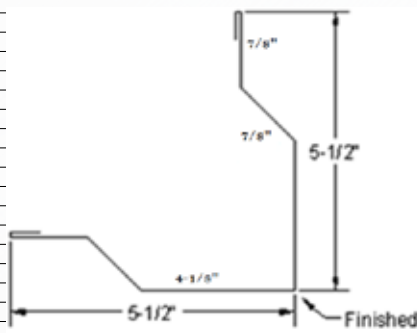

10' 6"	12' 6"	14' 6"	16' 6"	3-1/2" x 3-1/2" Rake & Corner
RC10	RC40	RC60	RC80	Galv
RC11	RC41	RC61	RC81	White
RC12	RC42	RC62	RC82	Green
RC13	RC43	RC63	RC83	Lightstone
RC14	RC44	RC64	RC84	Taupe
RC15	RC45	RC65	RC85	Ash Gray
RC16	RC46	RC66	RC86	Ocean Blue
RC17	RC47	RC67	RC87	Tan
RC18	RC48	RC68	RC88	Charcoal Gray
RC19	RC49	RC69	RC89	Red
RC20	RC50	RC70	RC90	Brown
RC21	RC51	RC71	RC91	Black
RC22	RC52	RC72	RC92	Burgundy
RC23	RC53	RC73	RC93	Bone Wht
RC24	RC54	RC74	RC94	Antique Bronze
RC25	RC55	RC75	RC95	Hess Green
RC26	RC56	RC76	RC96	Brite Red
RC27	RC57	RC77	RC97	Dark Blue
RC28	RC58	RC78	RC98	Pewter Gray
RC29	RC59	RC79	RC99	Copper Penny
RC32	RC34	RC36	RC100	Covert Green
RC33	RC35	RC37	RC101	Shale Green

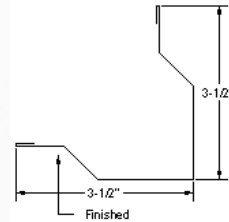

10' 6"	3-1/2" x 5-1/2" Rake Trim	10' 6"	7-1/2" x 5-1/2" Rake Trim
RT10	Galv	RT60	Galv
RT11	White	RT61	White
RT12	Green	RT62	Green
RT13	Lightstone	RT63	Lightstone
RT14	Taupe	RT64	Taupe
RT15	Ash Gray	RT65	Ash Gray
RT16	Ocean Blue	RT66	Ocean Blue
RT17	Tan	RT67	Tan
RT18	Charcoal Gray	RT68	Charcoal Gray
RT19	Red	RT69	Red
RT20	Brown	RT70	Brown
RT21	Black	RT71	Black
RT22	Burgundy	RT72	Burgundy
RT23	Bone Wht	RT73	Bone Wht
RT24	Antique Bronze	RT74	Antique Bronze
RT25	Hess Green	RT75	Hess Green
RT26	Brite Red	RT76	Brite Red
RT27	Dark Blue	RT77	Dark Blue
RT28	Pewter Gray	RT78	Pewter Gray
RT29	Copper Penny	RT79	Copper Penny
RT32	Covert Green	RT80	Covert Green
RT33	Shale Green	RT81	Shale Green

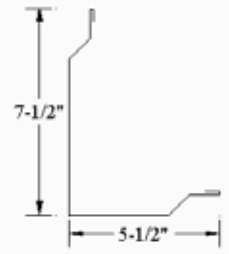
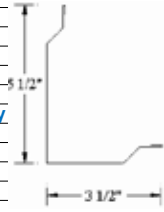

4"		6"		1-3/4"		Eave Trim	
ET10	ET40	ET60	Galv				
ET11	ET41	ET61	White				
ET12	ET42	ET62	Green				
ET13	ET43	ET63	Lightstone				
ET14	ET44	ET64	Taupe				
ET15	ET45	ET65	Ash Gray				
ET16	ET46	ET66	Ocean Blue				
ET17	ET47	ET67	Tan				
ET18	ET48	ET68	Charcoal Gray				
ET19	ET49	ET69	Red				
ET20	ET50	ET70	Brown				
ET21	ET51	ET71	Black				
ET22	ET52	ET72	Burgundy				
ET23	ET53	ET73	Bone Wht				
ET24	ET54	ET74	Antique Bronze				
ET25	ET55	ET75	Hess Green				
ET26	ET56	ET76	Brite Red				
ET27	ET57	ET77	Dark Blue				
ET28	ET58	ET78	Pewter Gray				
ET29	ET59	ET79	Copper Penny				
ET32	ET34	ET80	Covert Green				
ET33	ET35	ET81	Shale Green				

5-1/2"		7-1/2"		3-1/2"		Post Trim	
PT10	PT40	PT60	Galv				
PT11	PT41	PT61	White				
PT12	PT42	PT62	Green				
PT13	PT43	PT63	Lightstone				
PT14	PT44	PT64	Taupe				
PT15	PT45	PT65	Ash Gray				
PT16	PT46	PT66	Ocean Blue				
PT17	PT47	PT67	Tan				
PT18	PT48	PT68	Charcoal Gray				
PT19	PT49	PT69	Red				
PT20	PT50	PT70	Brown				
PT21	PT51	PT71	Black				
PT22	PT52	PT72	Burgundy				
PT23	PT53	PT73	Bone Wht				
PT24	PT54	PT74	Antique Bronze				
PT25	PT55	PT75	Hess Green				
PT26	PT56	PT76	Brite Red				
PT27	PT57	PT77	Dark Blue				
PT28	PT58	PT78	Pewter Gray				
PT29	PT59	PT79	Copper Penny				
PT32	PT34	PT36	Covert Green				
PT33	PT35	PT37	Shale Green				

3"		2"		1-1/2"		Angle Flashing	
IAF10	IAF40	IAF60	Galv				
IAF11	IAF41	IAF61	White				
IAF12	IAF42	IAF62	Green				
IAF13	IAF43	IAF63	Lightstone				
IAF14	IAF44	IAF64	Taupe				
IAF15	IAF45	IAF65	Ash Gray				
IAF16	IAF46	IAF66	Ocean Blue				
IAF17	IAF47	IAF67	Tan				
IAF18	IAF48	IAF68	Charcoal Gray				
IAF19	IAF49	IAF69	Red				
IAF20	IAF50	IAF70	Brown				
IAF21	IAF51	IAF71	Black				
IAF22	IAF52	IAF72	Burgundy				
IAF23	IAF53	IAF73	Bone Wht				
IAF24	IAF54	IAF74	Antique Bronze				
IAF25	IAF55	IAF75	Hess Green				
IAF26	IAF56	IAF76	Brite Red				
IAF27	IAF57	IAF77	Dark Blue				
IAF28	IAF58	IAF78	Pewter Gray				
IAF29	IAF59	IAF79	Copper Penny				
IAF32	IAF34	IAF80	Covert Green				
IAF33	IAF35	IAF81	Shale Green				

6"		8"		10"		Fascia Trim	
FT10	FT40	FT60	Galv				
FT11	FT41	FT61	White				
FT12	FT42	FT62	Green				
FT13	FT43	FT63	Lightstone				
FT14	FT44	FT64	Taupe				
FT15	FT45	FT65	Ash Gray				
FT16	FT46	FT66	Ocean Blue				
FT17	FT47	FT67	Tan				
FT18	FT48	FT68	Charcoal Gray				
FT19	FT49	FT69	Red				
FT20	FT50	FT70	Brown				
FT21	FT51	FT71	Black				
FT22	FT52	FT72	Burgundy				
FT23	FT53	FT73	Bone Wht				
FT24	FT54	FT74	Antique Bronze				
FT25	FT55	FT75	Hess Green				
FT26	FT56	FT76	Brite Red				
FT27	FT57	FT77	Dark Blue				
FT28	FT58	FT78	Pewter Gray				
FT29	FT59	FT79	Copper Penny				
FT32	FT34	FT80	Covert Green				
FT33	FT35	FT81	Shale Green				

14"	20"	
RID10	RID40	Galv
RID11	RID41	White
RID12	RID42	Green
RID13	RID43	Lightstone
RID14	RID44	Taupe
RID15	RID45	Ash Gray
RID16	RID46	Ocean Blue
RID17	RID47	Tan
RID18	RID48	Charcoal Gray
RID19	RID49	Red
RID20	RID50	Brown
RID21	RID51	Black
RID22	RID52	Burgundy
RID23	RID53	Bone Wht
RID24	RID54	Antique Bronze
RID25	RID55	Hess Green
RID26	RID56	Brite Red
RID27	RID57	Dark Blue
RID28	RID58	Pewter Gray
RID29	RID59	Copper Penny
RID32	RID34	Covert Green
RID33	RID35	Shale Green

14" & 20" Ridge Cap

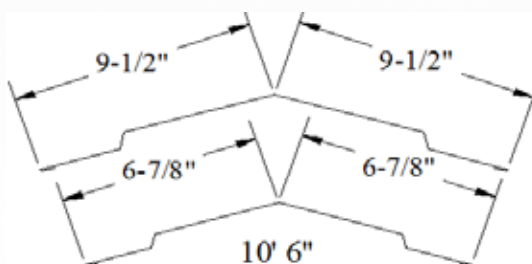

7"	9"	
OH10	OH40	Galv
OH11	OH41	White
OH12	OH42	Green
OH13	OH43	Lightstone
OH14	OH44	Taupe
OH15	OH45	Ash Gray
OH16	OH46	Ocean Blue
OH17	OH47	Tan
OH18	OH48	Charcoal Gray
OH19	OH49	Red
OH20	OH50	Brown
OH21	OH51	Black
OH22	OH52	Burgundy
OH23	OH53	Bone Wht
OH24	OH54	Antique Bronze
OH25	OH55	Hess Green
OH26	OH56	Brite Red
OH27	OH57	Dark Blue
OH28	OH58	Pewter Gray
OH29	OH59	Copper Penny
OH32	OH60	Covert Green
OH33	OH61	Shale Green

7" & 9" (O-H) Door w/Drip

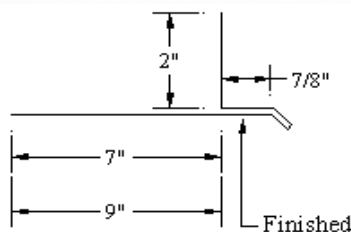

1/2" x 7/8"		
DJ10		Galv
DJ11	1/2" x 7/8"	White
DJ12		Green
DJ13		Lightstone
DJ14		Taupe
DJ15		Ash Gray
DJ16		Ocean Blue
DJ17		Tan
DJ18		Charcoal Gray
DJ19		Red
DJ20		Brown
DJ21		Black
DJ22		Burgundy
DJ23		Bone Wht
DJ24		Antique Bronze
DJ25		Hess Green
DJ26		Brite Red
DJ27		Dark Blue
DJ28		Pewter Gray
DJ29		Copper Penny
DJ32		Covert Green
DJ33		Shale Green

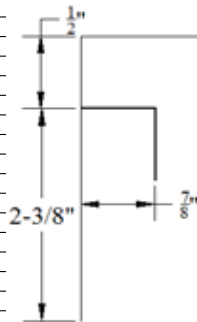

Double J Trim	7/8" x 7/8"	
DJ40		Galv
DJ41	7/8" x 7/8"	White
DJ42		Green
DJ43		Lightstone
DJ44		Taupe
DJ45		Ash Gray
DJ46		Ocean Blue
DJ47		Tan
DJ48		Charcoal Gray
DJ49		Red
DJ50		Brown
DJ51		Black
DJ52		Burgundy
DJ53		Bone Wht
DJ54		Antique Bronze
DJ55		Hess Green
DJ56		Brite Red
DJ57		Dark Blue
DJ58		Pewter Gray
DJ59		Copper Penny
DJ34		Covert Green
DJ35		Shale Green

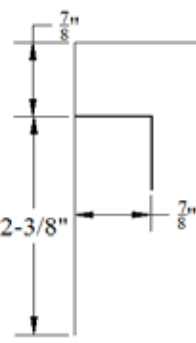

10' 6"	Length	12' 6"	Length	
JT40		JT10		Galv
JT41		JT11		White
JT42		JT12		Green
JT43		JT13		Lightstone
JT44		JT14		Taupe
JT45		JT15		Ash Gray
JT46		JT16		Ocean Blue
JT47		JT17		Tan
JT48		JT18		Charcoal Gray
JT49		JT19		Red
JT50		JT20		Brown
JT51		JT21		Black
JT52		JT22		Burgundy
JT53		JT23		Bone Wht
JT54		JT24		Antique Bronze
JT55		JT25		Hess Green
JT56		JT26		Brite Red
JT57		JT27		Dark Blue
JT58		JT28		Pewter Gray
JT59		JT29		Copper Penny
JT62		JT32		Covert Green
JT63		JT33		Shale Green

10' 6" & 12' 6" J Trim

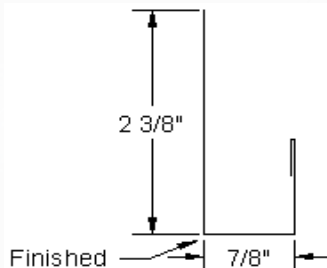

Wall & Ceiling Trim		Sidewall Flashing			
WC10 Galv		SF10 Galv			
WC11 White		SF11 White			
WC12 Green		SF12 Green			
WC13 Lightstone		SF13 Lightstone			
WC14 Taupe		SF14 Taupe			
WC15 Ash Gray		SF15 Ash Gray			
WC16 Ocean Blue		SF16 Ocean Blue			
WC17 Tan		SF17 Tan			
WC18 Charcoal Gray		SF18 Charcoal Gray			
WC19 Red		SF19 Red			
WC20 Brown		SF20 Brown			
WC21 Black		SF21 Black			
WC22 Burgundy		SF22 Burgundy			
WC23 Bone Wht		SF23 Bone Wht			
WC24 Antique Bronze		SF24 Antique Bronze			
WC25 Hess Green		SF25 Hess Green			
WC26 Brite Red		SF26 Brite Red			
WC27 Dark Blue		SF27 Dark Blue			
WC28 Pewter Gray		SF28 Pewter Gray			
WC29 Copper Penny		SF29 Copper Penny			
WC32 Cover Green		SF32 Cover Green			
WC33 Shale Green		SF33 Shale Green			
Roof Edge		Starter Strip			
RE10 Galv				STS10 Galv	
RE11 White				STS11 White	
RE12 Green				STS12 Green	
RE13 Lightstone				STS13 Lightstone	
RE14 Taupe				STS14 Taupe	
RE15 Ash Gray				STS15 Ash Gray	
RE16 Ocean Blue				STS16 Ocean Blue	
RE17 Tan				STS17 Tan	
RE18 Charcoal Gray				STS18 Charcoal Gray	
RE19 Red				STS19 Red	
RE20 Brown	STS20 Brown				
RE21 Black	STS21 Black				
RE22 Burgundy	STS22 Burgundy				
RE23 Bone Wht	STS23 Bone Wht				
RE24 Antique Bronze	STS24 Antique Bronze				
RE25 Hess Green	STS25 Hess Green				
RE26 Brite Red	STS26 Brite Red				
RE27 Dark Blue	STS27 Dark Blue				
RE28 Pewter Gray	STS28 Pewter Gray				
RE29 Copper Penny	STS29 Copper Penny				
RE32 Cover Green	STS32 Cover Green				
RE33 Shale Green	STS33 Shale Green				
7/8" Double Angle			Base Moulding		
DAT10 Galv			BM10 Galv		
DAT11 White			BM11 White		
DAT12 Green			BM12 Green		
DAT13 Lightstone			BM13 Lightstone		
DAT14 Taupe			BM14 Taupe		
DAT15 Ash Gray			BM15 Ash Gray		
DAT16 Ocean Blue			BM16 Ocean Blue		
DAT17 Tan			BM17 Tan		
DAT18 Charcoal Gray			BM18 Charcoal Gray		
DAT19 Red			BM19 Red		
DAT20 Brown		BM20 Brown			
DAT21 Black		BM21 Black			
DAT22 Burgundy		BM22 Burgundy			
DAT23 Bone Wht		BM23 Bone Wht			
DAT24 Antique Bronze		BM24 Antique Bronze			
DAT25 Hess Green		BM25 Hess Green			
DAT26 Brite Red		BM26 Brite Red			
DAT27 Dark Blue		BM27 Dark Blue			
DAT28 Pewter Gray		BM28 Pewter Gray			
DAT29 Copper Penny		BM29 Copper Penny			
DAT32 Cover Green		BM32 Cover Green			
DAT33 Shale Green		BM33 Shale Green			
Inside Corner		1-1/2" Double Angle			
IC10 Galv			DAT40 Galv		
IC11 White			DAT41 White		
IC12 Green			DAT42 Green		
IC13 Lightstone			DAT43 Lightstone		
IC14 Taupe			DAT44 Taupe		
IC15 Ash Gray			DAT45 Ash Gray		
IC16 Ocean Blue			DAT46 Ocean Blue		
IC17 Tan			DAT47 Tan		
IC18 Charcoal Gray			DAT48 Charcoal Gray		
IC19 Red			DAT49 Red		
IC20 Brown	DAT50 Brown				
IC21 Black	DAT51 Black				
IC22 Burgundy	DAT52 Burgundy				
IC23 Bone Wht	DAT53 Bone Wht				
IC24 Antique Bronz	DAT54 Antique Bronze				
IC25 Hess Green	DAT55 Hess Green				
IC26 Brite Red	DAT56 Brite Red				
IC27 Dark Blue	DAT57 Dark Blue				
IC28 Pewter Gray	DAT58 Pewter Gray				
IC29 Copper Penny	DAT59 Copper Penny				
IC32 Cover Green	DAT60 Cover Green				
IC33 Shale Green	DAT61 Shale Green				

Hem Flashing		Endwall Sidewall			
HF10 Galv		ES10 Galv			
HF11 White		ES11 White			
HF12 Green		ES12 Green			
HF13 Lightstone		ES13 Lightstone			
HF14 Taupe		ES14 Taupe			
HF15 Ash Gray		ES15 Ash Gray			
HF16 Ocean Blue		ES16 Ocean Blue			
HF17 Tan		ES17 Tan			
HF18 Charcoal Gray		ES18 Charcoal Gray			
HF19 Red		ES19 Red			
HF20 Brown		ES20 Brown			
HF21 Black		ES21 Black			
HF22 Burgundy		ES22 Burgundy			
HF23 Bone Wht		ES23 Bone Wht			
HF24 Antique Bronze		ES24 Antique Bronze			
HF25 Hess Green		ES25 Hess Green			
HF26 Brite Red		ES26 Brite Red			
HF27 Dark Blue		ES27 Dark Blue			
HF28 Pewter Gray		ES28 Pewter Gray			
HF29 Copper Penny		ES29 Copper Penny			
HF32 Covert Green		ES32 Covert Green			
HF33 Shale Green		ES33 Shale Green			
Box end Fascia		Gutter Apron			
BE10 Galv				GA10 Galv	
BE11 White				GA11 White	
BE12 Green				GA12 Green	
BE13 Lightstone				GA13 Lightstone	
BE14 Taupe				GA14 Taupe	
BE15 Ash Gray				GA15 Ash Gray	
BE16 Ocean Blue				GA16 Ocean Blue	
BE17 Tan				GA17 Tan	
BE18 Charcoal Gray				GA18 Charcoal Gray	
BE19 Red				GA19 Red	
BE20 Brown	GA20 Brown				
BE21 Black	GA21 Black				
BE22 Burgundy	GA22 Burgundy				
BE23 Bone Wht	GA23 Bone Wht				
BE24 Antique Bronze	GA24 Antique Bronze				
BE25 Hess Green	GA25 Hess Green				
BE26 Brite Red	GA26 Brite Red				
BE27 Dark Blue	GA27 Dark Blue				
BE28 Pewter Gray	GA28 Pewter Gray				
BE29 Copper Penny	GA29 Copper Penny				
BE32 Covert Green	GA32 Covert Green				
BE33 Shale Green	GA33 Shale Green				
20" Valley Trim		26" Valley Trim			
VT10 Galv		VT40 Galv			
VT11 White		VT41 White			
VT12 Green		VT42 Green			
VT13 Lightstone		VT43 Lightstone			
VT14 Taupe		VT44 Taupe			
VT15 Ash Gray		VT45 Ash Gray			
VT16 Ocean Blue		VT46 Ocean Blue			
VT17 Tan		VT47 Tan			
VT18 Charcoal Gray		VT48 Charcoal Gray			
VT19 Red		VT49 Red			
VT20 Brown		VT50 Brown			
VT21 Black		VT51 Black			
VT22 Burgundy		VT52 Burgundy			
VT23 Bone Wht		VT53 Bone Wht			
VT24 Antique Bronze	VT54 Antique Bronze				
VT25 Hess Green	VT55 Hess Green				
VT26 Brite Red	VT56 Brite Red				
VT27 Dark Blue	VT57 Dark Blue				
VT28 Pewter Gray	VT58 Pewter Gray				
VT29 Copper Penny	VT59 Copper Penny				
VT32 Covert Green	VT60 Covert Green				
VT33 Shale Green	VT61 Shale Green				
Universal Sidewall		Rake & Gable Trim			
UN10 Galv		UN40 Galv			
UN11 White		UN41 White			
UN12 Green		UN42 Green			
UN13 Lightstone		UN43 Lightstone			
UN14 Taupe		UN44 Taupe			
UN15 Ash Gray		UN45 Ash Gray			
UN16 Ocean Blue		UN46 Ocean Blue			
UN17 Tan		UN47 Tan			
UN18 Charcoal Gray		UN48 Charcoal Gray			
UN19 Red		UN49 Red			
UN20 Brown		UN50 Brown			
UN21 Black		UN51 Black			
UN22 Burgundy		UN52 Burgundy			
UN23 Bone Wht		UN53 Bone Wht			
UN24 Antique Bronze	UN54 Antique Bronze				
UN25 Hess Green	UN55 Hess Green				
UN26 Brite Red	UN56 Brite Red				
UN27 Dark Blue	UN57 Dark Blue				
UN28 Pewter Gray	UN58 Pewter Gray				
UN29 Copper Penny	UN59 Copper Penny				
UN32 Covert Green	UN60 Covert Green				
UN33 Shale Green	UN61 Shale Green				

Track Board Cover		Brick Mold Cover																																																																																									
<table border="0"> <tr><td>TB10</td><td>Galv</td></tr> <tr><td>TB11</td><td>White</td></tr> <tr><td>TB12</td><td>Green</td></tr> <tr><td>TB13</td><td>Lightstone</td></tr> <tr><td>TB14</td><td>Taupe</td></tr> <tr><td>TB15</td><td>Ash Gray</td></tr> <tr><td>TB16</td><td>Ocean Blue</td></tr> <tr><td>TB17</td><td>Tan</td></tr> <tr><td>TB18</td><td>Charcoal Gray</td></tr> <tr><td>TB19</td><td>Red</td></tr> <tr><td>TB20</td><td>Brown</td></tr> <tr><td>TB21</td><td>Black</td></tr> <tr><td>TB22</td><td>Burgundy</td></tr> <tr><td>TB23</td><td>Bone Wht</td></tr> <tr><td>TB24</td><td>Antique Bronze</td></tr> <tr><td>TB25</td><td>Hess Green</td></tr> <tr><td>TB26</td><td>Brite Red</td></tr> <tr><td>TB27</td><td>Dark Blue</td></tr> <tr><td>TB28</td><td>Pewter Gray</td></tr> <tr><td>TB29</td><td>Copper Penny</td></tr> <tr><td>TB32</td><td>Covert Green</td></tr> <tr><td>TB33</td><td>Shale Green</td></tr> </table>	TB10	Galv	TB11	White	TB12	Green	TB13	Lightstone	TB14	Taupe	TB15	Ash Gray	TB16	Ocean Blue	TB17	Tan	TB18	Charcoal Gray	TB19	Red	TB20	Brown	TB21	Black	TB22	Burgundy	TB23	Bone Wht	TB24	Antique Bronze	TB25	Hess Green	TB26	Brite Red	TB27	Dark Blue	TB28	Pewter Gray	TB29	Copper Penny	TB32	Covert Green	TB33	Shale Green		<table border="0"> <tr><td>BK10</td><td>Galv</td></tr> <tr><td>BK11</td><td>White</td></tr> <tr><td>BK12</td><td>Green</td></tr> <tr><td>BK13</td><td>Lightstone</td></tr> <tr><td>BK14</td><td>Taupe</td></tr> <tr><td>BK15</td><td>Ash Gray</td></tr> <tr><td>BK16</td><td>Ocean Blue</td></tr> <tr><td>BK17</td><td>Tan</td></tr> <tr><td>BK18</td><td>Charcoal Gray</td></tr> <tr><td>BK19</td><td>Red</td></tr> <tr><td>BK20</td><td>Brown</td></tr> <tr><td>BK21</td><td>Black</td></tr> <tr><td>BK22</td><td>Burgundy</td></tr> <tr><td>BK23</td><td>Bone Wht</td></tr> <tr><td>BK24</td><td>Antique Bronze</td></tr> <tr><td>BK25</td><td>Hess Green</td></tr> <tr><td>BK26</td><td>Brite Red</td></tr> <tr><td>BK27</td><td>Dark Blue</td></tr> <tr><td>BK28</td><td>Pewter Gray</td></tr> <tr><td>BK29</td><td>Copper Penny</td></tr> <tr><td>BK32</td><td>Covert Green</td></tr> <tr><td>BK33</td><td>Shale Green</td></tr> </table>	BK10	Galv	BK11	White	BK12	Green	BK13	Lightstone	BK14	Taupe	BK15	Ash Gray	BK16	Ocean Blue	BK17	Tan	BK18	Charcoal Gray	BK19	Red	BK20	Brown	BK21	Black	BK22	Burgundy	BK23	Bone Wht	BK24	Antique Bronze	BK25	Hess Green	BK26	Brite Red	BK27	Dark Blue	BK28	Pewter Gray	BK29	Copper Penny	BK32	Covert Green	BK33	Shale Green	
TB10	Galv																																																																																										
TB11	White																																																																																										
TB12	Green																																																																																										
TB13	Lightstone																																																																																										
TB14	Taupe																																																																																										
TB15	Ash Gray																																																																																										
TB16	Ocean Blue																																																																																										
TB17	Tan																																																																																										
TB18	Charcoal Gray																																																																																										
TB19	Red																																																																																										
TB20	Brown																																																																																										
TB21	Black																																																																																										
TB22	Burgundy																																																																																										
TB23	Bone Wht																																																																																										
TB24	Antique Bronze																																																																																										
TB25	Hess Green																																																																																										
TB26	Brite Red																																																																																										
TB27	Dark Blue																																																																																										
TB28	Pewter Gray																																																																																										
TB29	Copper Penny																																																																																										
TB32	Covert Green																																																																																										
TB33	Shale Green																																																																																										
BK10	Galv																																																																																										
BK11	White																																																																																										
BK12	Green																																																																																										
BK13	Lightstone																																																																																										
BK14	Taupe																																																																																										
BK15	Ash Gray																																																																																										
BK16	Ocean Blue																																																																																										
BK17	Tan																																																																																										
BK18	Charcoal Gray																																																																																										
BK19	Red																																																																																										
BK20	Brown																																																																																										
BK21	Black																																																																																										
BK22	Burgundy																																																																																										
BK23	Bone Wht																																																																																										
BK24	Antique Bronze																																																																																										
BK25	Hess Green																																																																																										
BK26	Brite Red																																																																																										
BK27	Dark Blue																																																																																										
BK28	Pewter Gray																																																																																										
BK29	Copper Penny																																																																																										
BK32	Covert Green																																																																																										
BK33	Shale Green																																																																																										
Track Cover		Soffit Trim																																																																																									
<table border="0"> <tr><td>TC10</td><td>Galv</td></tr> <tr><td>TC11</td><td>White</td></tr> <tr><td>TC12</td><td>Green</td></tr> <tr><td>TC13</td><td>Lightstone</td></tr> <tr><td>TC14</td><td>Taupe</td></tr> <tr><td>TC15</td><td>Ash Gray</td></tr> <tr><td>TC16</td><td>Ocean Blue</td></tr> <tr><td>TC17</td><td>Tan</td></tr> <tr><td>TC18</td><td>Charcoal Gray</td></tr> <tr><td>TC19</td><td>Red</td></tr> <tr><td>TC20</td><td>Brown</td></tr> <tr><td>TC21</td><td>Black</td></tr> <tr><td>TC22</td><td>Burgundy</td></tr> <tr><td>TC23</td><td>Bone Wht</td></tr> <tr><td>TC24</td><td>Antique Bronze</td></tr> <tr><td>TC25</td><td>Hess Green</td></tr> <tr><td>TC26</td><td>Brite Red</td></tr> <tr><td>TC27</td><td>Dark Blue</td></tr> <tr><td>TC28</td><td>Pewter Gray</td></tr> <tr><td>TC29</td><td>Copper Penny</td></tr> <tr><td>TC32</td><td>Covert Green</td></tr> <tr><td>TC33</td><td>Shale Green</td></tr> </table>	TC10	Galv	TC11	White	TC12	Green	TC13	Lightstone	TC14	Taupe	TC15	Ash Gray	TC16	Ocean Blue	TC17	Tan	TC18	Charcoal Gray	TC19	Red	TC20	Brown	TC21	Black	TC22	Burgundy	TC23	Bone Wht	TC24	Antique Bronze	TC25	Hess Green	TC26	Brite Red	TC27	Dark Blue	TC28	Pewter Gray	TC29	Copper Penny	TC32	Covert Green	TC33	Shale Green		<table border="0"> <tr><td>SOF10</td><td>Galv</td></tr> <tr><td>SOF11</td><td>White</td></tr> <tr><td>SOF12</td><td>Green</td></tr> <tr><td>SOF13</td><td>Lightstone</td></tr> <tr><td>SOF14</td><td>Taupe</td></tr> <tr><td>SOF15</td><td>Ash Gray</td></tr> <tr><td>SOF16</td><td>Ocean Blue</td></tr> <tr><td>SOF17</td><td>Tan</td></tr> <tr><td>SOF18</td><td>Charcoal Gray</td></tr> <tr><td>SOF19</td><td>Red</td></tr> <tr><td>SOF20</td><td>Brown</td></tr> <tr><td>SOF21</td><td>Black</td></tr> <tr><td>SOF22</td><td>Burgundy</td></tr> <tr><td>SOF23</td><td>Bone Wht</td></tr> <tr><td>SOF24</td><td>Antique Bronze</td></tr> <tr><td>SOF25</td><td>Hess Green</td></tr> <tr><td>SOF26</td><td>Brite Red</td></tr> <tr><td>SOF27</td><td>Dark Blue</td></tr> <tr><td>SOF28</td><td>Pewter Gray</td></tr> <tr><td>SOF29</td><td>Copper Penny</td></tr> <tr><td>SOF32</td><td>Covert Green</td></tr> <tr><td>SOF33</td><td>Shale Green</td></tr> </table>	SOF10	Galv	SOF11	White	SOF12	Green	SOF13	Lightstone	SOF14	Taupe	SOF15	Ash Gray	SOF16	Ocean Blue	SOF17	Tan	SOF18	Charcoal Gray	SOF19	Red	SOF20	Brown	SOF21	Black	SOF22	Burgundy	SOF23	Bone Wht	SOF24	Antique Bronze	SOF25	Hess Green	SOF26	Brite Red	SOF27	Dark Blue	SOF28	Pewter Gray	SOF29	Copper Penny	SOF32	Covert Green	SOF33	Shale Green	
TC10	Galv																																																																																										
TC11	White																																																																																										
TC12	Green																																																																																										
TC13	Lightstone																																																																																										
TC14	Taupe																																																																																										
TC15	Ash Gray																																																																																										
TC16	Ocean Blue																																																																																										
TC17	Tan																																																																																										
TC18	Charcoal Gray																																																																																										
TC19	Red																																																																																										
TC20	Brown																																																																																										
TC21	Black																																																																																										
TC22	Burgundy																																																																																										
TC23	Bone Wht																																																																																										
TC24	Antique Bronze																																																																																										
TC25	Hess Green																																																																																										
TC26	Brite Red																																																																																										
TC27	Dark Blue																																																																																										
TC28	Pewter Gray																																																																																										
TC29	Copper Penny																																																																																										
TC32	Covert Green																																																																																										
TC33	Shale Green																																																																																										
SOF10	Galv																																																																																										
SOF11	White																																																																																										
SOF12	Green																																																																																										
SOF13	Lightstone																																																																																										
SOF14	Taupe																																																																																										
SOF15	Ash Gray																																																																																										
SOF16	Ocean Blue																																																																																										
SOF17	Tan																																																																																										
SOF18	Charcoal Gray																																																																																										
SOF19	Red																																																																																										
SOF20	Brown																																																																																										
SOF21	Black																																																																																										
SOF22	Burgundy																																																																																										
SOF23	Bone Wht																																																																																										
SOF24	Antique Bronze																																																																																										
SOF25	Hess Green																																																																																										
SOF26	Brite Red																																																																																										
SOF27	Dark Blue																																																																																										
SOF28	Pewter Gray																																																																																										
SOF29	Copper Penny																																																																																										
SOF32	Covert Green																																																																																										
SOF33	Shale Green																																																																																										
Door Header		Drip Cap																																																																																									
<table border="0"> <tr><td>DH10</td><td>Galv</td></tr> <tr><td>DH11</td><td>White</td></tr> <tr><td>DH12</td><td>Green</td></tr> <tr><td>DH13</td><td>Lightstone</td></tr> <tr><td>DH14</td><td>Taupe</td></tr> <tr><td>DH15</td><td>Ash Gray</td></tr> <tr><td>DH16</td><td>Ocean Blue</td></tr> <tr><td>DH17</td><td>Tan</td></tr> <tr><td>DH18</td><td>Charcoal Gray</td></tr> <tr><td>DH19</td><td>Red</td></tr> <tr><td>DH20</td><td>Brown</td></tr> <tr><td>DH21</td><td>Black</td></tr> <tr><td>DH22</td><td>Burgundy</td></tr> <tr><td>DH23</td><td>Bone Wht</td></tr> <tr><td>DH24</td><td>Antique Bronze</td></tr> <tr><td>DH25</td><td>Hess Green</td></tr> <tr><td>DH26</td><td>Brite Red</td></tr> <tr><td>DH27</td><td>Dark Blue</td></tr> <tr><td>DH28</td><td>Pewter Gray</td></tr> <tr><td>DH29</td><td>Copper Penny</td></tr> <tr><td>DH32</td><td>Covert Green</td></tr> <tr><td>DH33</td><td>Shale Green</td></tr> </table>	DH10	Galv	DH11	White	DH12	Green	DH13	Lightstone	DH14	Taupe	DH15	Ash Gray	DH16	Ocean Blue	DH17	Tan	DH18	Charcoal Gray	DH19	Red	DH20	Brown	DH21	Black	DH22	Burgundy	DH23	Bone Wht	DH24	Antique Bronze	DH25	Hess Green	DH26	Brite Red	DH27	Dark Blue	DH28	Pewter Gray	DH29	Copper Penny	DH32	Covert Green	DH33	Shale Green		<table border="0"> <tr><td>DC10</td><td>Galv</td></tr> <tr><td>DC11</td><td>White</td></tr> <tr><td>DC12</td><td>Green</td></tr> <tr><td>DC13</td><td>Lightstone</td></tr> <tr><td>DC14</td><td>Taupe</td></tr> <tr><td>DC15</td><td>Ash Gray</td></tr> <tr><td>DC16</td><td>Ocean Blue</td></tr> <tr><td>DC17</td><td>Tan</td></tr> <tr><td>DC18</td><td>Charcoal Gray</td></tr> <tr><td>DC19</td><td>Red</td></tr> <tr><td>DC20</td><td>Brown</td></tr> <tr><td>DC21</td><td>Black</td></tr> <tr><td>DC22</td><td>Burgundy</td></tr> <tr><td>DC23</td><td>Bone Wht</td></tr> <tr><td>DC24</td><td>Antique Bronze</td></tr> <tr><td>DC25</td><td>Hess Green</td></tr> <tr><td>DC26</td><td>Brite Red</td></tr> <tr><td>DC27</td><td>Dark Blue</td></tr> <tr><td>DC28</td><td>Pewter Gray</td></tr> <tr><td>DC29</td><td>Copper Penny</td></tr> <tr><td>DC32</td><td>Covert Green</td></tr> <tr><td>DC33</td><td>Shale Green</td></tr> </table>	DC10	Galv	DC11	White	DC12	Green	DC13	Lightstone	DC14	Taupe	DC15	Ash Gray	DC16	Ocean Blue	DC17	Tan	DC18	Charcoal Gray	DC19	Red	DC20	Brown	DC21	Black	DC22	Burgundy	DC23	Bone Wht	DC24	Antique Bronze	DC25	Hess Green	DC26	Brite Red	DC27	Dark Blue	DC28	Pewter Gray	DC29	Copper Penny	DC32	Covert Green	DC33	Shale Green	
DH10	Galv																																																																																										
DH11	White																																																																																										
DH12	Green																																																																																										
DH13	Lightstone																																																																																										
DH14	Taupe																																																																																										
DH15	Ash Gray																																																																																										
DH16	Ocean Blue																																																																																										
DH17	Tan																																																																																										
DH18	Charcoal Gray																																																																																										
DH19	Red																																																																																										
DH20	Brown																																																																																										
DH21	Black																																																																																										
DH22	Burgundy																																																																																										
DH23	Bone Wht																																																																																										
DH24	Antique Bronze																																																																																										
DH25	Hess Green																																																																																										
DH26	Brite Red																																																																																										
DH27	Dark Blue																																																																																										
DH28	Pewter Gray																																																																																										
DH29	Copper Penny																																																																																										
DH32	Covert Green																																																																																										
DH33	Shale Green																																																																																										
DC10	Galv																																																																																										
DC11	White																																																																																										
DC12	Green																																																																																										
DC13	Lightstone																																																																																										
DC14	Taupe																																																																																										
DC15	Ash Gray																																																																																										
DC16	Ocean Blue																																																																																										
DC17	Tan																																																																																										
DC18	Charcoal Gray																																																																																										
DC19	Red																																																																																										
DC20	Brown																																																																																										
DC21	Black																																																																																										
DC22	Burgundy																																																																																										
DC23	Bone Wht																																																																																										
DC24	Antique Bronze																																																																																										
DC25	Hess Green																																																																																										
DC26	Brite Red																																																																																										
DC27	Dark Blue																																																																																										
DC28	Pewter Gray																																																																																										
DC29	Copper Penny																																																																																										
DC32	Covert Green																																																																																										
DC33	Shale Green																																																																																										
Bull Nose Trim		Snow Guard																																																																																									
<table border="0"> <tr><td>BC10</td><td>Galv</td></tr> <tr><td>BC11</td><td>White</td></tr> <tr><td>BC12</td><td>Green</td></tr> <tr><td>BC13</td><td>Lightstone</td></tr> <tr><td>BC14</td><td>Taupe</td></tr> <tr><td>BC15</td><td>Ash Gray</td></tr> <tr><td>BC16</td><td>Ocean Blue</td></tr> <tr><td>BC17</td><td>Tan</td></tr> <tr><td>BC18</td><td>Charcoal Gray</td></tr> <tr><td>BC19</td><td>Red</td></tr> <tr><td>BC20</td><td>Brown</td></tr> <tr><td>BC21</td><td>Black</td></tr> <tr><td>BC22</td><td>Burgundy</td></tr> <tr><td>BC23</td><td>Bone Wht</td></tr> <tr><td>BC24</td><td>Antique Bronze</td></tr> <tr><td>BC25</td><td>Hess Green</td></tr> <tr><td>BC26</td><td>Brite Red</td></tr> <tr><td>BC27</td><td>Dark Blue</td></tr> <tr><td>BC28</td><td>Pewter Gray</td></tr> <tr><td>BC29</td><td>Copper Penny</td></tr> <tr><td>BC32</td><td>Covert Green</td></tr> <tr><td>BC33</td><td>Shale Green</td></tr> </table>	BC10	Galv	BC11	White	BC12	Green	BC13	Lightstone	BC14	Taupe	BC15	Ash Gray	BC16	Ocean Blue	BC17	Tan	BC18	Charcoal Gray	BC19	Red	BC20	Brown	BC21	Black	BC22	Burgundy	BC23	Bone Wht	BC24	Antique Bronze	BC25	Hess Green	BC26	Brite Red	BC27	Dark Blue	BC28	Pewter Gray	BC29	Copper Penny	BC32	Covert Green	BC33	Shale Green		<table border="0"> <tr><td>SG11</td><td>Galv</td></tr> <tr><td>SG12</td><td>White</td></tr> <tr><td>SG13</td><td>Lightstone</td></tr> <tr><td>SG14</td><td>Taupe</td></tr> <tr><td>SG15</td><td>Ash Gray</td></tr> <tr><td>SG16</td><td>Ocean Blue</td></tr> <tr><td>SG17</td><td>Tan</td></tr> <tr><td>SG18</td><td>Charcoal Gray</td></tr> <tr><td>SG19</td><td>Red</td></tr> <tr><td>SG20</td><td>Brown</td></tr> <tr><td>SG21</td><td>Black</td></tr> <tr><td>SG22</td><td>Burgundy</td></tr> <tr><td>SG23</td><td>Bone Wht</td></tr> <tr><td>SG24</td><td>Antique Bronze</td></tr> <tr><td>SG25</td><td>Hess Green</td></tr> <tr><td>SG26</td><td>Brite Red</td></tr> <tr><td>SG27</td><td>Dark Blue</td></tr> <tr><td>SG28</td><td>Pewter Gray</td></tr> <tr><td>SG29</td><td>Copper Penny</td></tr> <tr><td>SG32</td><td>Covert Green</td></tr> <tr><td>SG33</td><td>Shale Green</td></tr> </table>	SG11	Galv	SG12	White	SG13	Lightstone	SG14	Taupe	SG15	Ash Gray	SG16	Ocean Blue	SG17	Tan	SG18	Charcoal Gray	SG19	Red	SG20	Brown	SG21	Black	SG22	Burgundy	SG23	Bone Wht	SG24	Antique Bronze	SG25	Hess Green	SG26	Brite Red	SG27	Dark Blue	SG28	Pewter Gray	SG29	Copper Penny	SG32	Covert Green	SG33	Shale Green			
BC10	Galv																																																																																										
BC11	White																																																																																										
BC12	Green																																																																																										
BC13	Lightstone																																																																																										
BC14	Taupe																																																																																										
BC15	Ash Gray																																																																																										
BC16	Ocean Blue																																																																																										
BC17	Tan																																																																																										
BC18	Charcoal Gray																																																																																										
BC19	Red																																																																																										
BC20	Brown																																																																																										
BC21	Black																																																																																										
BC22	Burgundy																																																																																										
BC23	Bone Wht																																																																																										
BC24	Antique Bronze																																																																																										
BC25	Hess Green																																																																																										
BC26	Brite Red																																																																																										
BC27	Dark Blue																																																																																										
BC28	Pewter Gray																																																																																										
BC29	Copper Penny																																																																																										
BC32	Covert Green																																																																																										
BC33	Shale Green																																																																																										
SG11	Galv																																																																																										
SG12	White																																																																																										
SG13	Lightstone																																																																																										
SG14	Taupe																																																																																										
SG15	Ash Gray																																																																																										
SG16	Ocean Blue																																																																																										
SG17	Tan																																																																																										
SG18	Charcoal Gray																																																																																										
SG19	Red																																																																																										
SG20	Brown																																																																																										
SG21	Black																																																																																										
SG22	Burgundy																																																																																										
SG23	Bone Wht																																																																																										
SG24	Antique Bronze																																																																																										
SG25	Hess Green																																																																																										
SG26	Brite Red																																																																																										
SG27	Dark Blue																																																																																										
SG28	Pewter Gray																																																																																										
SG29	Copper Penny																																																																																										
SG32	Covert Green																																																																																										
SG33	Shale Green																																																																																										

- CR10 Galv
- CR11 White
- CR12 Green
- CR13 Lightstone
- CR14 Taupe
- CR15 Ash Gray
- CR16 Ocean Blue
- CR17 Tan
- CR18 Charcoal Gray
- CR19 Red
- CR20 Brown
- CR21 Black
- CR22 Burgundy
- CR23 Bone Wht
- CR24 Antique Bronze
- CR25 Hess Green
- CR26 Brite Red
- CR27 Dark Blue
- CR28 Pewter Gray
- CR29 Copper Penny
- CR32 Covert Green
- CR33 Shale Green

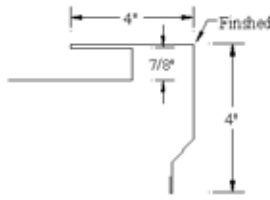

- CL10 Galv
- CL11 White
- CL12 Green
- CL13 Lightstone
- CL14 Taupe
- CL15 Ash Gray
- CL16 Ocean Blue
- CL17 Tan
- CL18 Charcoal Gray
- CL19 Red
- CL20 Brown
- CL21 Black
- CL22 Burgundy
- CL23 Bone Wht
- CL24 Antique Bronze
- CL25 Hess Green
- CL26 Brite Red
- CL27 Dark Blue
- CL28 Pewter Gray
- CL29 Copper Penny
- CL32 Covert Green
- CL33 Shale Green

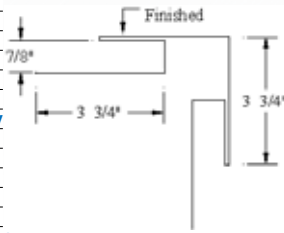

Hip Ridge Cap

Special Valley

- HR10 Galv
- HR11 White
- HR12 Green
- HR13 Lightstone
- HR14 Taupe
- HR15 Ash Gray
- HR16 Ocean Blue
- HR17 Tan
- HR18 Charcoal Gray
- HR19 Red
- HR20 Brown
- HR21 Black
- HR22 Burgundy
- HR23 Bone Wht
- HR24 Antique Bronze
- HR25 Hess Green
- HR26 Brite Red
- HR27 Dark Blue
- HR28 Pewter Gray
- HR29 Copper Penny
- HR32 Covert Green
- HR33 Shale Green



- SV10 Galv
- SV11 White
- SV12 Green
- SV13 Lightstone
- SV14 Taupe
- SV15 Ash Gray
- SV16 Ocean Blue
- SV17 Tan
- SV18 Charcoal Gray
- SV19 Red
- SV20 Brown
- SV21 Black
- SV22 Burgundy
- SV23 Bone Wht
- SV24 Antique Bronze
- SV25 Hess Green
- SV26 Brite Red
- SV27 Dark Blue
- SV28 Pewter Gray
- SV29 Copper Penny
- SV32 Covert Green
- SV33 Shale Green



Heel Fascia

Reversed Ridge

- HE10 Galv
- HE11 White
- HE12 Green
- HE13 Lightstone
- HE14 Taupe
- HE15 Ash Gray
- HE16 Ocean Blue
- HE17 Tan
- HE18 Charcoal Gray
- HE19 Red
- HE20 Brown
- HE21 Black
- HE22 Burgundy
- HE23 Bone Wht
- HE24 Antique Bronze
- HE25 Hess Green
- HE26 Brite Red
- HE27 Dark Blue
- HE28 Pewter Gray
- HE29 Copper Penny
- HE32 Covert Green
- HE33 Shale Green

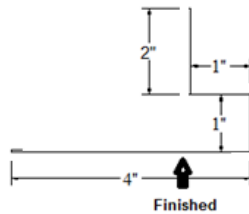

- RR10 Galv
- RR11 White
- RR12 Green
- RR13 Lightstone
- RR14 Taupe
- RR15 Ash Gray
- RR16 Ocean Blue
- RR17 Tan
- RR18 Charcoal Gray
- RR19 Red
- RR20 Brown
- RR21 Black
- RR22 Burgundy
- RR23 Bone Wht
- RR24 Antique Bronze
- RR25 Hess Green
- RR26 Brite Red
- RR27 Dark Blue
- RR28 Pewter Gray
- RR29 Copper Penny
- RR32 Covert Green
- RR33 Shale Green



Gambrel Flash

Eave & Gable Trim

- GH10 Galv
- GH11 White
- GH12 Green
- GH13 Lightstone
- GH14 Taupe
- GH15 Ash Gray
- GH16 Ocean Blue
- GH17 Tan
- GH18 Charcoal Gray
- GH19 Red
- GH20 Brown
- GH21 Black
- GH22 Burgundy
- GH23 Bone Wht
- GH24 Antique Bronze
- GH25 Hess Green
- GH26 Brite Red
- GH27 Dark Blue
- GH28 Pewter Gray
- GH29 Copper Penny
- GH32 Covert Green
- GH33 Shale Green

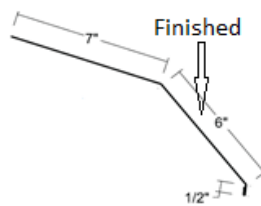

- EG10 Galv
- EG11 White
- EG12 Green
- EG13 Lightstone
- EG14 Taupe
- EG15 Ash Gray
- EG16 Ocean Blue
- EG17 Tan
- EG18 Charcoal Gray
- EG19 Red
- EG20 Brown
- EG21 Black
- EG22 Burgundy
- EG23 Bone Wht
- EG24 Antique Bronze
- EG25 Hess Green
- EG26 Brite Red
- EG27 Dark Blue
- EG28 Pewter Gray
- EG29 Copper Penny
- EG32 Covert Green
- EG33 Shale Green



Framing Closure			Soffit Trim	
FM10	Galv		FJ10	Galv
FM11	White		FJ11	White
FM12	Green		FJ12	Green
FM13	Lightstone		FJ13	Lightstone
FM14	Taupe		FJ14	Taupe
FM15	Ash Gray		FJ15	Ash Gray
FM16	Ocean Blue		FJ16	Ocean Blue
FM17	Tan		FJ17	Tan
FM18	Charcoal Gray		FJ18	Charcoal Gray
FM19	Red		FJ19	Red
FM20	Brown		FJ20	Brown
FM21	Black		FJ21	Black
FM22	Burgundy		FJ22	Burgundy
FM23	Bone Wht		FJ23	Bone Wht
FM24	Antique Bronze		FJ24	Antique Bronze
FM25	Hess Green		FJ25	Hess Green
FM26	Brite Red		FJ26	Brite Red
FM27	Dark Blue		FJ27	Dark Blue
FM28	Pewter Gray		FJ28	Pewter Gray
FM29	Copper Penny		FJ29	Copper Penny
FM32	Covert Green		FJ32	Covert Green
FM33	Shale Green		FJ33	Shale Green

3/8" Soffit Divider			3/8" Soffit - F - Channel	
SE10	Galv		SN10	Galv
SE11	White		SN11	White
SE12	Green		SN12	Green
SE13	Lightstone		SN13	Lightstone
SE14	Taupe		SN14	Taupe
SE15	Ash Gray		SN15	Ash Gray
SE16	Ocean Blue		SN16	Ocean Blue
SE17	Tan		SN17	Tan
SE18	Charcoal Gray		SN18	Charcoal Gray
SE19	Red		SN19	Red
SE20	Brown		SN20	Brown
SE21	Black		SN21	Black
SE22	Burgundy		SN22	Burgundy
SE23	Bone Wht		SN23	Bone Wht
SE24	Antique Bronze		SN24	Antique Bronze
SE25	Hess Green		SN25	Hess Green
SE26	Brite Red		SN26	Brite Red
SE27	Dark Blue	SN27	Dark Blue	
SE28	Pewter Gray	SN28	Pewter Gray	
SE29	Copper Penny	SN29	Copper Penny	
SE32	Covert Green	SN32	Covert Green	
SE33	Shale Green	SN33	Shale Green	

F Trim			24" Poly Carboned	
FTR10	Galv		SLR24	
FTR11	White			
FTR12	Green			
FTR13	Lightstone			
FTR14	Taupe			
FTR15	Ash Gray			
FTR16	Ocean Blue			
FTR17	Tan			
FTR18	Charcoal Gray			
FTR19	Red			
FTR20	Brown			
FTR21	Black			
FTR22	Burgundy			
FTR23	Bone Wht			
FTR24	Antique Bronze			
FTR25	Hess Green			
FTR26	Brite Red			
FTR27	Dark Blue			
FTR28	Pewter Gray			
FTR29	Copper Penny			
FTR32	Covert Green			
FTR33	Shale Green			



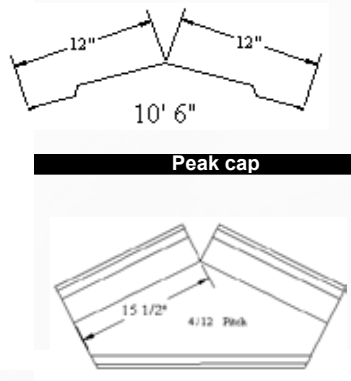



5/8" Panel-rib J			Snow Stop	
PR10	Galv		SM10	Galv
PR11	White		SM11	White
PR12	Green		SM12	Green
PR13	Lightstone		SM13	Lightstone
PR14	Taupe		SM14	Taupe
PR15	Ash Gray		SM15	Ash Gray
PR16	Ocean Blue		SM16	Ocean Blue
PR17	Tan		SM17	Tan
PR18	Charcoal Gray		SM18	Charcoal Gray
PR19	Red		SM19	Red
PR20	Brown		SM20	Brown
PR21	Black		SM21	Black
PR22	Burgundy		SM22	Burgundy
PR23	Bone Wht		SM23	Bone Wht
PR24	Antique Bronze		SM24	Antique Bronze
PR25	Hess Green		SM25	Hess Green
PR26	Brite Red		SM26	Brite Red
PR27	Dark Blue	SM27	Dark Blue	
PR28	Pewter Gray	SM28	Pewter Gray	
PR29	Copper Penny	SM29	Copper Penny	
PR32	Covert Green	SM32	Covert Green	
PR33	Shale Green	SM33	Shale Green	



Peak Cap \$18.38

Peak cap

Metal to Wood Screws		Metal to Wood Screws	
ITEM		ITEM	
SCR10	250/Bag # 10 X 1" Galvanize	SCR100	250/Bag # 10 X 3" Galvanized
SCR11	250/Bag # 10 X 1" White	SCR101	250/Bag # 10 X 3" White
SCR12	250/Bag # 10 X 1" Green	SCR102	250/Bag # 10 X 3" Green
SCR13	250/Bag # 10 X 1" Light Stone	SCR103	250/Bag # 10 X 3" Lightstone
SCR14	250/Bag # 10 X 1" Taupe	SCR104	250/Bag # 10 X 3" Taupe
SCR15	250/Bag # 10 X 1" Ash Gray	SCR105	250/Bag # 10 X 3" Ash Gray
SCR16	250/Bag # 10 X 1" Ocean Blue	SCR106	250/Bag # 10 X 3" Ocean Blue
SCR17	250/Bag # 10 X 1" Tan	SCR107	250/Bag # 10 X 3" Tan
SCR18	250/Bag # 10 X 1" Charcoal Gray	SCR108	250/Bag # 10 X 3" Charcoal Gray
SCR19	250/Bag # 10 X 1" Red	SCR109	250/Bag # 10 X 3" Red
SCR20	250/Bag # 10 X 1" Brown	SCR110	250/Bag # 10 X 3" Brown
SCR21	250/Bag # 10 X 1" Black	SCR111	250/Bag # 10 X 3" Black
SCR22	250/Bag # 10 X 1" Burgundy	SCR112	250/Bag # 10 X 3" Burgundy
SCR23	250/Bag # 10 X 1" Bone Wht	SCR113	250/Bag # 10 X 3" Bone Wht
SCR24	250/Bag # 10 X 1" Antique Bronze	SCR114	250/Bag # 10 X 3" Antique Bronze
SCR25	250/Bag # 10 X 1" Hess Green	SCR115	250/Bag # 10 X 3" Hess Green
SCR26	250/Bag # 10 X 1" Brite Red	SCR116	250/Bag # 10 X 3" Brite Red
SCR27	250/Bag # 10 X 1" Dark Blue	SCR117	250/Bag # 10 X 3" Dark Blue
SCR28	250/Bag # 10 X 1" Pewter Gray	SCR118	250/Bag # 10 X 3" Pewter Gray
SCR29	250/Bag # 10 X 1" Copper Penny	SCR119	250/Bag # 10 X 3" Copper Penny
SCR30	250/Bag # 10 X 1" Covert Green	SCR120	250/Bag # 10 X 3" Covert Green
SCR31	250/Bag # 10 X 1" Shale Green	SCR121	250/Bag # 10 X 3" Shale Green
Metal to Wood Screws		Wafer Clip Screws	
SCR40	250/Bag # 10 X 1-1/2" Galvanize	WS10	250/Bag 10 x 1" SQ/Phil Wafer Clip Screws
SCR41	250/Bag # 10 X 1-1/2" White	WS11	250/Bag 10 x 1-1/2" SQ/Phil Wafer Clip Screws
SCR42	250/Bag # 10 X 1-1/2" Green		
SCR43	250/Bag # 10 X 1-1/2" Light Stone		
SCR44	250/Bag # 10 X 1-1/2" Taupe		
SCR45	250/Bag # 10 X 1-1/2" Ash Gray		
SCR46	250/Bag # 10 X 1-1/2" Ocean Blue		
SCR47	250/Bag # 10 X 1-1/2" Tan		
SCR48	250/Bag # 10 X 1-1/2" Charcoal Gray		
SCR49	250/Bag # 10 X 1-1/2" Red		
SCR50	250/Bag # 10 X 1-1/2" Brown		
SCR51	250/Bag # 10 X 1-1/2" Black	Lum11	White Aluminum 250/Bag # 10 x 1" wood Screw
SCR52	250/Bag # 10 X 1-1/2" Burgundy	Lum41	White Alum 250/Bag #10 x 1-1/2" wood Screw
SCR53	250/Bag # 10 X 1-1/2" Bone Wht		
SCR54	250/Bag # 10 X 1-1/2" Antique Bronze		
SCR55	250/Bag # 10 X 1-1/2" Hess Green		
SCR56	250/Bag # 10 X 1-1/2" Brite Red		
SCR57	250/Bag # 10 X 1-1/2" Dark Blue		
SCR58	250/Bag # 10 X 1-1/2" Pewter Gray		
SCR59	250/Bag # 10 X 1-1/2" Copper Penny		
SCR32	250/Bag # 10 X 1-1/2" Covert Green		
SCR33	250/Bag # 10 X 1-1/2" Shale Green		
Metal to Wood Screws		Eclipse Lo-profile wood screw	
SCR60	250/Bag # 10 X 2" Galvanize	FQ50	Eclipse torques # T25 - Bit
SCR61	250/Bag # 10 X 2" White	LP11	250/Bag # 10 x 1-1/2" White
SCR62	250/Bag # 10 X 2" Green	LP12	250/Bag # 10 x 1-1/2" Green
SCR63	250/Bag # 10 X 2" Light Stone	LP13	250/Bag # 10 x 1-1/2" Lightstone
SCR64	250/Bag # 10 X 2" Taupe	LP14	250/Bag # 10 x 1-1/2" Taupe
SCR65	250/Bag # 10 X 2" Ash Gray	LP15	250/Bag # 10 x 1-1/2" Ash Gray
SCR66	250/Bag # 10 X 2" Ocean Blue	LP16	250/Bag # 10 x 1-1/2" Ocean Blue
SCR67	250/Bag # 10 X 2" Tan	LP17	250/Bag # 10 x 1-1/2" Tan
SCR68	250/Bag # 10 X 2" Charcoal Gray	LP18	250/Bag # 10 x 1-1/2" Charcoal Gray
SCR69	250/Bag # 10 X 2" Red	LP19	250/Bag # 10 x 1-1/2" Red
SCR70	250/Bag # 10 X 2" Brown	LP20	250/Bag # 10 x 1-1/2" Brown
SCR71	250/Bag # 10 X 2" Black	LP21	250/Bag # 10 x 1-1/2" Black
SCR72	250/Bag # 10 X 2" Burgundy	LP22	250/Bag # 10 x 1-1/2" Burgundy
SCR73	250/Bag # 10 X 2" Bone Wht	LP23	250/Bag # 10 x 1-1/2" Bone Wht
SCR74	250/Bag # 10 X 2" Antique Bronze	LP24	250/Bag # 10 x 1-1/2" Antique Bronze
SCR75	250/Bag # 10 X 2" Hess Green	LP25	250/Bag # 10 X 1-1/2" Hess Green
SCR76	250/Bag # 10 X 2" Brite Red	LP26	250/Bag # 10 X 1-1/2" Brite Red
SCR77	250/Bag # 10 X 2" Dark Blue	LP27	250/Bag # 10 X 1-1/2" Dark Blue
SCR78	250/Bag # 10 X 2" Pewter Gray	LP28	250/Bag # 10 X 1-1/2" Pewter Gray
SCR79	250/Bag # 10 X 2" Copper Penny	LP29	250/Bag # 10 X 1-1/2" Copper Penny
SCR34	250/Bag # 10 X 2" Covert Green	LP32	250/Bag # 10 X 1-1/2" Covert Green
SCR35	250/Bag # 10 X 2" Shale Green	LP33	250/Bag # 10 X 1-1/2" Shale Green
		LP41	250/Bag # 10 X 2" White
		LP60	250/Bag # 10 X 2-1/2" Galvanized
		LP61	250/Bag # 10 X 2-1/2" White
Metal to Wood Screws		Metal to Wood Screws	
SCR80	250/Bag # 10 X 2-1/2" Galvanize	SCR140	250/Bag # 10 X 4" Galvanized
SCR81	250/Bag # 10 X 2-1/2" White	SCR141	250/Bag # 10 X 4" White
SCR82	250/Bag # 10 X 2-1/2" Green		
SCR83	250/Bag # 10 X 2-1/2" Light Stone		
SCR84	250/Bag # 10 X 2-1/2" Taupe		
SCR85	250/Bag # 10 X 2-1/2" Ash Gray		
SCR86	250/Bag # 10 X 2-1/2" Ocean Blue		
SCR87	250/Bag # 10 X 2-1/2" Tan		
SCR88	250/Bag # 10 X 2-1/2" Charcoal Gray		
SCR89	250/Bag # 10 X 2-1/2" Red		
SCR90	250/Bag # 10 X 2-1/2" Brown		
SCR91	250/Bag # 10 X 2-1/2" Black		
SCR92	250/Bag # 10 X 2-1/2" Burgundy		
SCR93	250/Bag # 10 X 2-1/2" Bone Wht		
SCR94	250/Bag # 10 X 2-1/2" Antique Bronze		
SCR95	250/Bag # 10 X 2-1/2" Hess Green		
SCR96	250/Bag # 10 X 2-1/2" Brite Red		
SCR97	250/Bag # 10 X 2-1/2" Dark Blue		
SCR98	250/Bag # 10 X 2-1/2" Pewter Gray		
SCR99	250/Bag # 10 X 2-1/2" Copper Penny		
SCR36	250/Bag # 10 X 2-1/2" Covert Green		
SCR37	250/Bag # 10 X 2-1/2" Shale Green		
		SCR200	250/Bag # 10 X 1" Stainless Screws
		SCR201	250/Bag # 10 X 1" Stainless Screws White
		SCR240	250/Bag # 10 X 1 1/2" SS Screws
		SCR241	250/Bag # 10 X 1 1/2" SS Screws White
		SCR260	250/Bag # 10 X 2" Stainless Screws
		SCR261	250/Bag # 10 X 2" Stainless Screws White
		SCR280	250/Bag # 10 X 2-1/2" Stainless Screws
		SCR281	250/Bag # 10 X 2-1/2" Stainless Screws White
		SCR300	250/Bag # 10 X 3" Stainless Screws
		SCR301	250/Bag # 10 X 3" Stainless Screws White

ITEM		Self Drillers	ITEM	Lap Stitch Screws	
MD10	250/Bag # 12 X 1" Galvanize		LS10	250/Bag # 12 X 3/4" Stitch Galvanized	
MD11	250/Bag # 12 X 1" White		LS11	250/Bag # 12 X 3/4" Stitch White	
MD12	250/Bag # 12 X 1" Green		LS12	250/Bag # 12 X 3/4" Stitch Green	
MD13	250/Bag # 12 X 1" Light Stone		LS13	250/Bag # 12 X 3/4" Stitch Lightstone	
MD14	250/Bag # 12 X 1" Taupe		LS14	250/Bag # 12 X 3/4" Stitch Taupe	
MD15	250/Bag # 12 X 1" Ash Gray		LS15	250/Bag # 12 X 3/4" Stitch Ash Gray	
MD16	250/Bag # 12 X 1" Ocean Blue		LS16	250/Bag # 12 X 3/4" Stitch Ocean Blue	
MD17	250/Bag # 12 X 1" Tan		LS17	250/Bag # 12 X 3/4" Stitch Tan	
MD18	250/Bag # 12 X 1" Charcoal Gray		LS18	250/Bag # 12 X 3/4" Stitch Charcoal Gray	
MD19	250/Bag # 12 X 1" Red		LS19	250/Bag # 12 X 3/4" Stitch Red	
MD20	250/Bag # 12 X 1" Brown		LS20	250/Bag # 12 X 3/4" Stitch Brown	
MD21	250/Bag # 12 X 1" Black		LS21	250/Bag # 12 X 3/4" Stitch Black	
MD22	250/Bag # 12 X 1" Burgundy		LS22	250/Bag # 12 X 3/4" Stitch Burgundy	
MD23	250/Bag # 12 X 1" Bone Wht		LS23	250/Bag # 12 X 3/4" Stitch Bone Wht	
MD24	250/Bag # 12 X 1" Antique Bronze		LS24	250/Bag # 12 X 3/4" Stitch Antique Bronze	
MD25	250/Bag # 12 X 1" Hess Green		LS25	250/Bag # 12 X 3/4" Stitch Hess Green	
MD26	250/Bag # 12 X 1" Brite Red		LS26	250/Bag # 12 X 3/4" Stitch Brite Red	
MD27	250/Bag # 12 X 1" Dark Blue		LS27	250/Bag # 12 X 3/4" Stitch Dark Blue	
MD28	250/Bag # 12 X 1" Pewter Gray		LS28	250/Bag # 12 X 3/4" Stitch Pewter Gray	
MD29	250/Bag # 12 X 1" Copper Penny		LS29	250/Bag # 12 X 3/4" Stitch Copper Penny	
MD32	250/Bag # 12 X 1" Covert Green		LS32	250/Bag # 12 X 3/4" Stitch Covert Green	
MD33	250/Bag # 12 X 1" Shale Green		LS33	250/Bag # 12 X 3/4" Stitch Shale Green	
			Self Drillers		
MD40	250/Bag # 12 X 1-1/2" Galvanize			1/8" Stainless Rivet	
MD41	250/Bag # 12 X 1-1/2" White			PP10	250/Bag 1/8 x 3/16 Stainless Rivet Plain
MD42	250/Bag # 12 X 1-1/2" Green			PP11	250/Bag 1/8 x 3/16 Stainless Rivet White
MD43	250/Bag # 12 X 1-1/2" Light Stone			PP12	250/Bag 1/8 x 3/16 Stainless Rivet Green
MD44	250/Bag # 12 X 1-1/2" Taupe			PP13	250/Bag 1/8 x 3/16 Stainless Rivet Lightstone
MD45	250/Bag # 12 X 1-1/2" Ash Gray			PP14	250/Bag 1/8 x 3/16 Stainless Rivet Taupe
MD46	250/Bag # 12 X 1-1/2" Ocean Blue			PP15	250/Bag 1/8 x 3/16 Stainless Rivet Ash Gray
MD47	250/Bag # 12 X 1-1/2" Tan			PP16	250/Bag 1/8 x 3/16 Stainless Rivet Ocean Blue
MD48	250/Bag # 12 X 1-1/2" Charcoal Gray			PP17	250/Bag 1/8 x 3/16 Stainless Rivet Tan
MD49	250/Bag # 12 X 1-1/2" Red			PP18	250/Bag 1/8 x 3/16 Stainless Rivet Charcoal Gray
MD50	250/Bag # 12 X 1-1/2" Brown			PP19	250/Bag 1/8 x 3/16 Stainless Rivet Red
MD51	250/Bag # 12 X 1-1/2" Black	PP20		250/Bag 1/8 x 3/16 Stainless Rivet Brown	
MD52	250/Bag # 12 X 1-1/2" Burgundy	PP21		250/Bag 1/8 x 3/16 Stainless Rivet Black	
MD53	250/Bag # 12 X 1-1/2" Bone Wht	PP22		250/Bag 1/8 x 3/16 Stainless Rivet Burgundy	
MD54	250/Bag # 12 X 1-1/2" Antique Bronze	PP23		250/Bag 1/8 x 3/16 Stainless Rivet Bone Wht	
MD55	250/Bag # 12 X 1/1/2" Hess Green	PP24		250/Bag 1/8 x 3/16 Stainless Rivet Antique Bronze	
MD56	250/Bag # 12 X 1/1/2" Brite Red	PP26		250/Bag 1/8 x 3/16 Stainless Rivet Brite Red	
MD57	250/Bag # 12 X 1-1/2" Dark Blue	PP27		250/Bag 1/8 x 3/16 Stainless Rivet Dark Blue	
MD58	250/Bag # 12 X 1/1/2" Pewter Gray	PP28		250/Bag 1/8 x 3/16 Stainless Rivet Pewter Gray	
MD59	250/Bag # 12 X 1/1/2" Copper Penny	PP29		250/Bag 1/8 x 3/16 Stainless Rivet Copper Penny	
MD32	250/Bag # 12 X 1/1/2" Covert Green				
MD33	250/Bag # 12 X 1/1/2" Shale Green				
					
MD60	250/bag # 12 X 2" White			Stainless Self Drillers	
MD61	250/bag # 12 X 2" White			MD108	250/Bag # 12 x 3/4" Stitch
MD80	250/Bag # 12 x 2-1/2" Galv	MD110		250/Bag # 12 x 1" Self Driller	
MD81	250/Bag # 12 x 2-1/2" White	MD140		250/Bag # 12 x 1 1/4" Self Driller	
MD 8	250/Bag # 12 X 3/4" White				
MD 6	250/Bag # 12 X 1" White No Washer				
MD 4	250/Bag # 12 X 3/4" No Washer White				
MD280	250/Bag # 12-24 x 1 1/2" Galv	NS1			1/4" Nutsetter
MD281	250/Bag # 12-24 x 1 1/2" White	NS2		5/16" Nutsetter	
		NS3		3/8" Nutsetter	
		NS4		7/16" Nutsetter	

MWI Hardware

SQT	9.5 Adj. Trolley f/ Sq. Trk Pr		
JL7	2- Adj. 7" Jamb Latches Pr		
DSN	Wood Frame Door Snugger		
DPG DPW	Jumbo Zinc Door Pull Jumbo White Door Pull		
DST ADJ	Heavy Duty Door Stop Ajust-A-Stop White		
STR	Offset- Adj. Stay Roller		
STM	Stop Jamb Mount		
FL15	# 3 Extreme Pitch 1/4" - 6 1/4" Pipe Diameter		
RF20	Retco Fit Master Flash 3/4" to 2-3/4"		
RF21	Retco Fit Master Flash 2" to 7-1/4"		
RF22	Retco Fit Master Flash 3-1/4" to 10"		
RF23	Retco Fit Master Flash 9-1/4 to 16"		
FL3	# 3 Flasher 1/4" to 5"		
FL5	# 5 Flasher 4-1/2 to 7-1/2"		
FL8	# 8 Flasher 7" to 13"		
FL9	# 9 Flasher 10" to 19"		
FL4	Hi-Temp - 100* to 450* 1/4" to 5"		
FL6	Hi-Temp - 100* to 450* 4-1/2 to 7-1/2"		
FL10	Hi-Temp - 100* to 450* 7" to 13"		
FL12	Hi-Temp - 100* to 450* 10" to 19"		
DL10	Stainless Steel Door Lock		
DL12	Heavy Duty Stainless Steel Door Lock		
DL16	Entrance Lever lock		
DL22	Heavy Duty Entrance Lever lock		
DL24	2-3/4 Dead Bolt		

Doors

- WD11 **3/0 x 6/8 Actual unit size 38-5/8" x 80-5/8"**
AS3 Walk Door 3/0 x 6/8
- WD2 **AS3 Walk Door 3/0 x 6/8 RH 20" x 24" 1-Lite**
- WD4 **AS3 Walk Door 3/0 x 6/8 LH 20" x 24" 1-Lite**
- WD16 **4/0 x 6/8 Actual unit size 49-1/2" x 80-5/8"**
AS3 Walk Door 4/0 x 6/8



- WD20 **6/0 x 6/8 Actual unit size 75" x 81"**
AS3 Walk Door 6/0 x 6/8
- WD12 **3/0 x 6/8 Actual unit size 38-5/8" x 80-5/8"**
T-8 Thermal Walk Door 3/0 x 6/8
- WD13 **T-8 Thermal Walk Door 3/0 x 6/8 RH 20" x 24" 1-Lite**
- WD14 **T-8 Thermal Walk Door 3/0 x 6/8 LH 20" x 24" 1-Lite**
- WD18 **4/0 x 6/8 Actual unit size 49-1/2" x 80-5/8"**
T-8 Thermal Walk Door 4/0 x 6/8

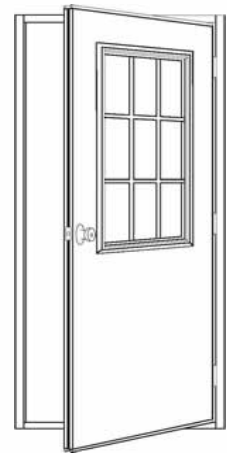

- WD24 **6/0 x 6/8 Actual unit size 75" x 81-3/8"**
T-8 Thermal Walk Door 6/0 x 6/8

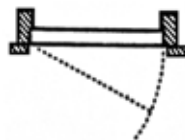
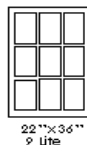
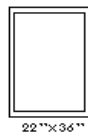

Left Hand Outswing

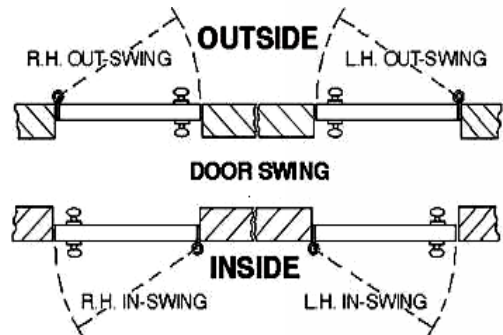

- WLP1 **22" x 36" Door lite package**
- WLP2 **9-lite - 22" x 36" Door lite package**
- WLP3 **20" x 24" Door lite package**

Windows

- SW10 **36X24 Window W/J-Channel White Sliding Window-Insulated**
- SW11 **36X36 Window W/J-Channel White Sliding Window-Insulated**
- SW12 **48X36 Window W/J-Channel White Sliding Window-Insulated**



MWI Ridgevents

RV41	RV25 10' Ridgevent (2.1 square ft.per vent) White
RV42	RV25 10' Ridgevent (2.1 square ft.per vent) Green
RV44	RV25 10' Ridgevent (2.1 square ft.per vent) Taupe
RV45	RV25 10' Ridgevent (2.1 square ft.per vent) Ash Gray
RV46	RV25 10' Ridgevent (2.1 square ft.per vent) Ocean Blue
RV48	RV25 10' Ridgevent (2.1 square ft.per vent) Charcoal Gray
RV49	RV25 10' Ridgevent (2.1 square ft.per vent) Red
RV50	RV25 10' Ridgevent (2.1 square ft.per vent) Brown
RV52	RV25 10' Ridgevent (2.1 square ft.per vent) Burgundy
RV54	RV25 10' Ridgevent (2.1 square ft.per vent) Antique Bronze
RV58	RV25 10' Ridgevent (2.1 square ft.per vent) Pewter Gray

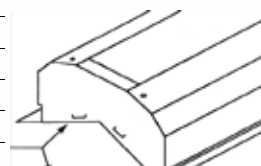

Weathervane Horse & Buggy - Horse - Cow - Pig - Chicken - Tractor & others available



C24	24" Cupola Any Color
-----	----------------------

C36	36" Cupola Any Color
-----	----------------------



R-Value R04

BB4	4' x 125' Double Bubble Insulation
-----	------------------------------------

BB6	6' x 125' Double Bubble Insulation
-----	------------------------------------

BB8	8' x 125' Double Bubble Insulation
-----	------------------------------------

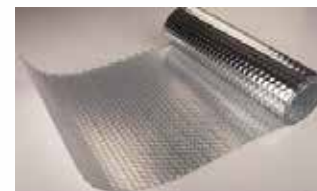

P2000 1/2" P2000 X 1/2" - 72' roll

WT1	3" x 150' Alumimun Tape
-----	-------------------------

WT2	3" x 160' White Tape
-----	----------------------

Spray11	Touch up Paint White
---------	----------------------

Spray12	Touch up Paint Green
---------	----------------------

Spray13	Touch up Paint Lightstone
---------	---------------------------

Spray14	Touch up Paint Taupe
---------	----------------------

Spray15	Touch up Paint Ash Gray
---------	-------------------------

Spray16	Touch up Paint Ocean Blue
---------	---------------------------

Spray17	Touch up Paint Tan
---------	--------------------

Spray18	Touch up Paint Charcoal Gray
---------	------------------------------

Spray19	Touch up Paint Red
---------	--------------------

Spray20	Touch up Paint Brown
---------	----------------------

Spray21	Touch up Paint Black
---------	----------------------

Spray22	Touch up Paint Burgundy
---------	-------------------------

Spray23	Touch up Paint Bone Wht
---------	-------------------------

Spray24	Touch up Paint Antique Bronze
---------	-------------------------------

Spray25	Touch up Paint Hess Green
---------	---------------------------

Spray26	Touch up Paint Brite Red
---------	--------------------------

Spray27	Touch up Paint Dark Blue
---------	--------------------------

Spray28	Touch up Paint Pewter Gary
---------	----------------------------

Spray29	Touch up Paint Copper Penny
---------	-----------------------------



CT40	1/2" x 3/32" / 50' Butyl or Mastix Tape
------	---

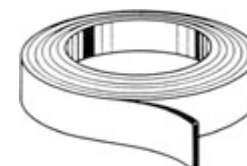

SG10 Snow Guard



MWI Hardware

SR10	10' Side Rail White
SR12	12' Side Rail White
SR14	14' Side Rail White
SR16	16' Side Rail White
SR18	18' Side Rail White

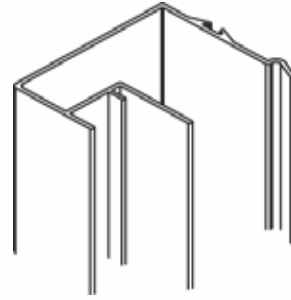

BR10	10' Bottom Rail White
BR12	12' Bottom Rail White
BR14	14' Bottom Rail White
BR16	16' Bottom Rail White
BR18	18' Bottom Rail White

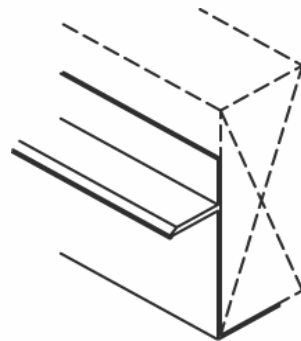

H10	10' "H" Rail White
H12	12' "H" Rail White
H14	14' "H" Rail White
H16	16' "H" Rail White
H18	18' "H" Rail White

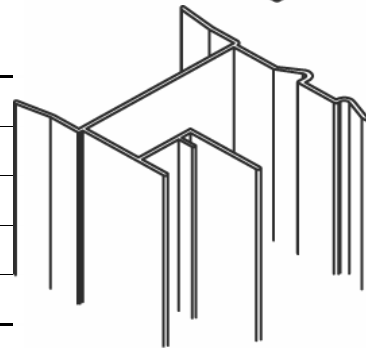

SQ10	10' Square Trk no cover
SQ12	12' Square Trk no cover
SQ14	14' Square Trk no cover
SQ16	16' Square Trk no cover
SQ20	20' Square Trk no cover

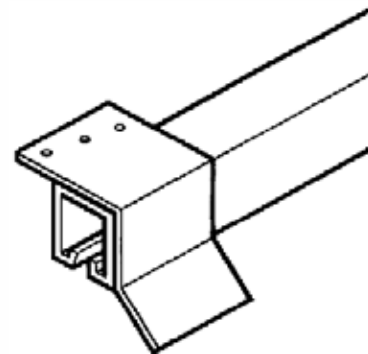
**(18 Ga) Cover**

STW10	10' Square Trk w/White Cover
STW12	12' Square Trk w/White Cover
STW14	14' Square Trk w/White Cover
STW16	16' Square Trk w/White Cover

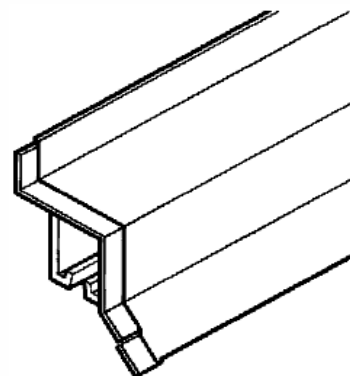

Item		26 Gauge	
RP10	R-Panel	{26ga} Galvanized	
RP11	R-Panel	{26ga} White	
RP12	R-Panel	{26ga} Green	
RP13	R-Panel	{26ga} Lightstone	
RP14	R-Panel	{26ga} Taupe	
RP15	R-Panel	{26ga} Ash Gray	
RP16	R-Panel	{26ga} Ocean Blue	
RP17	R-Panel	{26ga} Tan	
RP18	R-Panel	{26ga} Charcoal Gray	
RP19	R-Panel	{26ga} Red	
RP20	R-Panel	{26ga} Brown	
RP21	R-Panel	{26ga} Black	
RP22	R-Panel	{26ga} Burgundy	
RP23	R-Panel	{26ga} Bone Wht	
RP24	R-Panel	{26ga} Antique Bronze	
RP25	R-Panel	{26ga} Hess Green	
RP26	R-Panel	{26GA} Brite Red	
RP27	R-Panel	{26ga} Dark Blue	
RP28	R-Panel	{26ga} Pewter Gray	
RP32	R-Panel	{26ga} Covert Green	
RP33	R-Panel	{26ga} Shale Green	
RP60	R-Panel	{24ga} Galvalume	
RP61	R-Panel	{24ga} White	
RP38	R-Panel	{29ga} Liner Panel White	
RP68	R-Panel	{26ga} Liner Panel White	

UP10	U-Panel
UP11	U-Panel
UP12	U-Panel
UP13	U-Panel
UP14	U-Panel
UP15	U-Panel
UP16	U-Panel
UP17	U-Panel
UP18	U-Panel
UP19	U-Panel
UP20	U-Panel
UP21	U-Panel
UP22	U-Panel
UP23	U-Panel
UP24	U-Panel
UP25	U-Panel
UP26	U-Panel
UP27	U-Panel
UP28	U-Panel
UP32	U-Panel
UP33	U-Panel

RP98 12' R-Panel White Fiberglass Skylite 8 ounce

RP80 R-Panel - 18" x 18" Formed Ridgecap Galvalume
 RP81 R-Panel - 18" x 18" Formed Ridgecap All Colors

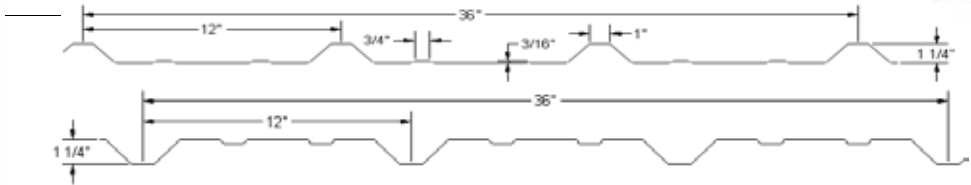

ATTN we run the V-rib the 15th of the month only

VR11	V-rib {26ga} White	
VR12	V-rib {26ga} Green	
VR13	V-rib {26ga} Lightstone	
VR14	V-rib {26ga} Taupe	
VR15	V-rib {26ga} Ash Gray	
VR16	V-rib {26ga} Ocean Blue	
VR17	V-rib {26ga} Tan	
VR18	V-rib {26ga} Charcoal Gray	
VR19	V-rib {26ga} Red	
VR20	V-rib {26ga} Brown	
VR21	V-rib {26ga} Black	
VR22	V-rib {26ga} Burgundy	
VR23	V-rib {26ga} Bone Wht	
VR24	V-rib {26ga} Antique Bronze	
VR25	V-rib {26ga} Hess Green	
VR26	V-rib {26ga} Brite Red	
VR27	V-rib {26ga} Dark Blue	
VR28	V-rib {26ga} Pewter Gray	
VR32	V-rib {26ga} Covert Green	
VR33	V-rib {26ga} Shale Green	

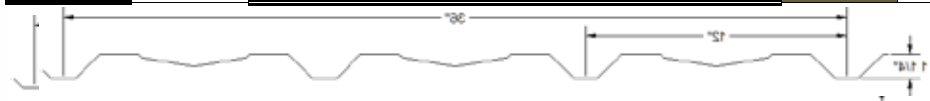

RP90 R-Panel - Large Outside Closures
 RP91 R-Panel - Small Inside Closures
 Profile Vent & Uniseal
 RP85 Low Profile Vent
 US12 1-1/2" x 1-1/2" Uniseal 20' roll



Item	R-Panel Dr!pstop 26 Gauge	
RD10	R-Panel Dr!pstop {26ga} Galvanized	
RD11	R-Panel Dr!pstop {26ga} White	
RD12	R-Panel Dr!pstop {26ga} Green	
RD13	R-Panel Dr!pstop {26ga} Lightstone	
RD14	R-Panel Dr!pstop {26ga} Taupe	
RD15	R-Panel Dr!pstop {26ga} Ash Gray	
RD16	R-Panel Dr!pstop {26ga} Ocean Blue	
RD17	R-Panel Dr!pstop {26ga} Tan	
RD18	R-Panel Dr!pstop {26ga} Charcoal Gray	
RD19	R-Panel Dr!pstop {26ga} Red	
RD20	R-Panel Dr!pstop {26ga} Brown	
RD21	R-Panel Dr!pstop {26ga} Black	
RD22	R-Panel Dr!pstop {26ga} Burgundy	
RD23	R-Panel Dr!pstop {26ga} Bone Wht	
RD24	R-Panel Dr!pstop {26ga} Antique Bronze	
RD25	R-Panel Dr!pstop {26ga} Hass Green	
RD26	R-Panel Dr!pstop {26ga} Brite Red	
RD27	R-Panel Dr!pstop {26ga} Dark Blue	
RD28	R-Panel Dr!pstop {26ga} Pewter Gray	
RD32	R-Panel Dr!pstop {26ga} Covert Green	
RD33	R-Panel Dr!pstop {26ga} Shale Green	

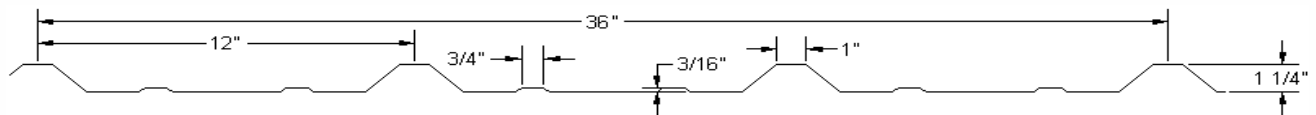

HT10	Galv
HT11	White
HT12	Green
HT13	Lightstone
HT14	Taupe
HT15	Ash Gray
HT16	Ocean Blue
HT17	Tan
HT18	Charcoal Gray
HT19	Red
HT20	Brown
HT21	Black
HT22	Burgundy
HT23	Bone Wht
HT24	Antique Bronze
HT25	Hess Green
HT26	Brite Red
HT27	Dark Blue
HT28	Pewter Gray
HT32	Covert Green
HT33	Shale Green

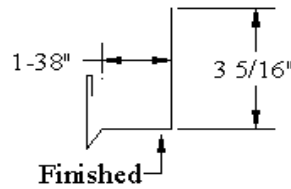

JM10	Galv
JM11	White
JM12	Green
JM13	Lightstone
JM14	Taupe
JM15	Ash Gray
JM16	Ocean Blue
JM17	Tan
JM18	Charcoal Gray
JM19	Red
JM20	Brown
JM21	Black
JM22	Burgundy
JM23	Bone Wht
JM24	Antique Bronze
JM25	Hess Green
JM26	Brite Red
JM27	Dark Blue
JM28	Pewter Gray
JM32	Covert Green
JM33	Shale Green

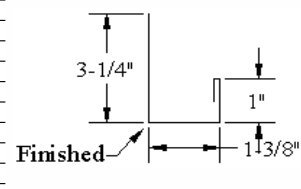

Eave Flashing

Base Closure Assembly

EF10	Galv
EF11	White
EF12	Green
EF13	Lightstone
EF14	Taupe
EF15	Ash Gray
EF16	Ocean Blue
EF17	Tan
EF18	Charcoal Gray
EF19	Red
EF20	Brown
EF21	Black
EF22	Burgundy
EF23	Bone Wht
EF24	Antique Bronze
EF25	Hess Green
EF26	Brite Red
EF27	Dark Blue
EF28	Pewter Gray
EF32	Covert Green
EF33	Shale Green

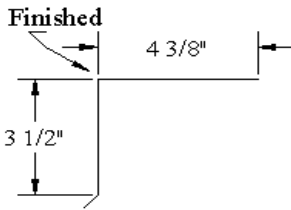

BA10	Galv
BA11	White
BA12	Green
BA13	Lightstone
BA14	Taupe
BA15	Ash Gray
BA16	Ocean Blue
BA17	Tan
BA18	Charcoal Gray
BA19	Red
BA20	Brown
BA21	Black
BA22	Burgundy
BA23	Bone Wht
BA24	Antique Bronze
BA25	Hess Green
BA26	Brite Red
BA27	Dark Blue
BA28	Pewter Gray
BA32	Covert Green
BA33	Shale Green

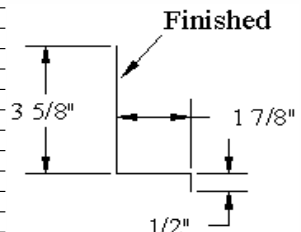

Zee Trim

Rat Guard

ZE10	Galv
ZE11	White
ZE12	Green
ZE13	Lightstone
ZE14	Taupe
ZE15	Ash Gray
ZE16	Ocean Blue
ZE17	Tan
ZE18	Charcoal Gray
ZE19	Red
ZE20	Brown
ZE21	Black
ZE22	Burgundy
ZE23	Bone Wht
ZE24	Antique Bronze
ZE25	Hess Green
ZE26	Brite Red
ZE27	Dark Blue
ZE28	Pewter Gray
ZE32	Covert Green
ZE33	Shale Green

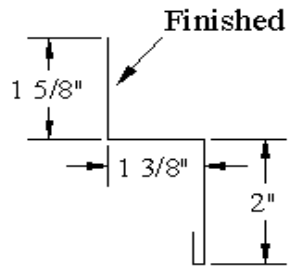

RG10	Galv
RG11	White
RG12	Green
RG13	Lightstone
RG14	Taupe
RG15	Ash Gray
RG16	Ocean Blue
RG17	Tan
RG18	Charcoal Gray
RG19	Red
RG20	Brown
RG21	Black
RG22	Burgundy
RG23	Bone Wht
RG24	Antique Bronze
RG25	Hess Green
RG26	Brite Red
RG27	Dark Blue
RG28	Pewter Gray
RG32	Covert Green
RG33	Shale Green

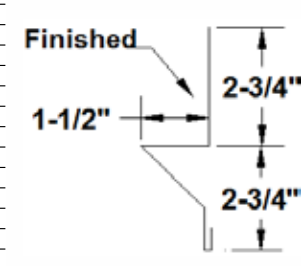

1-3/8" x 1-3/8" Double J Trim

1-3/8" x 7/8" Double J Trim

DJ81	White
DJ82	Green
DJ83	Lightstone
DJ84	Taupe
DJ85	Ash Gray
DJ86	Ocean Blue
DJ87	Tan
DJ88	Charcoal Gray
DJ89	Red
DJ90	Brown
DJ90	Black
DJ92	Burgundy
DJ93	Bone Wht
DJ94	Antique Bronze
DJ95	Hess Green
DJ96	Brite Red
DJ97	Dark Blue
DJ98	Pewter Gray
DJ99	Covert Green
DJ991	Shale Green

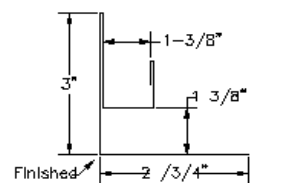

DJ60	Galv
DJ61	White
DJ62	Green
DJ63	Lightstone
DJ64	Taupe
DJ65	Ash Gray
DJ66	Ocean Blue
DJ67	Tan
DJ68	Charcoal Gray
DJ69	Red
DJ70	Brown
DJ71	Black
DJ72	Burgundy
DJ73	Bone Wht
DJ74	Antique Bronze
DJ75	Hess Green
DJ76	Brite Red
DJ77	Dark Blue
DJ78	Pewter Gray
DJ79	Covert Green
DJ80	Shale Green

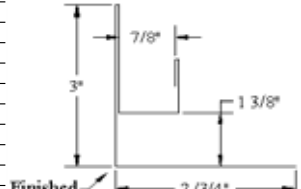

10' 6"	12' 6"	14' 6"	16' 6"	Corner Trim
CA10	CA40	CA60	CA80	Galv
CA11	CA41	CA61	CA81	White
CA12	CA42	CA62	CA82	Green
CA13	CA43	CA63	CA83	Lightstone
CA14	CA44	CA64	CA84	Taupe
CA15	CA45	CA65	CA85	Ash Gray
CA16	CA46	CA66	CA86	Ocean Blue
CA17	CA47	CA67	CA87	Tan
CA18	CA48	CA68	CA88	Charcoal Gray
CA19	CA49	CA69	CA89	Red
CA20	CA50	CA70	CA90	Brown
CA21	CA51	CA71	CA91	Black
CA22	CA52	CA72	CA92	Burgundy
CA23	CA53	CA73	CA93	Bone Wht
CA24	CA54	CA74	CA94	Antique Bronze
CA25	CA55	CA75	CA95	Hess Green
CA26	CA56	CA76	CA96	Brite Red
CA27	CA57	CA77	CA97	Dark Blue
CA28	CA58	CA78	CA98	Pewter Gray
CA32	CA34	CA36	CA38	Covert Green
CA33	CA35	CA37	CA39	Shale Green

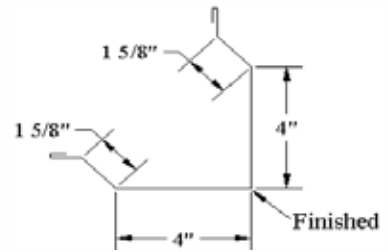

10' 6"	12' 6"	14' 6"	16' 6"	Inside Corner
IN10	IN40	IN60	IN80	Galv
IN11	IN41	IN61	IN81	White
IN12	IN42	IN62	IN82	Green
IN13	IN43	IN63	IN83	Lightstone
IN14	IN44	IN64	IN84	Taupe
IN15	IN45	IN65	IN85	Ash Gray
IN16	IN46	IN66	IN86	Ocean Blue
IN17	IN47	IN67	IN87	Tan
IN18	IN48	IN68	IN88	Charcoal Gray
IN19	IN49	IN69	IN89	Red
IN20	IN50	IN70	IN90	Brown
IN21	IN51	IN71	IN91	Black
IN22	IN52	IN72	IN92	Burgundy
IN23	IN53	IN73	IN93	Bone Wht
IN24	IN54	IN74	IN94	Antique Bronze
IN25	IN55	IN75	IN95	Hess Green
IN26	IN56	IN76	IN96	Brite Red
IN27	IN57	IN77	IN97	Dark Blue
IN28	IN58	IN78	IN98	Pewter Gray
IN32	IN34	IN36	IN38	Covert Green
IN33	IN35	IN37	IN39	Shale Green

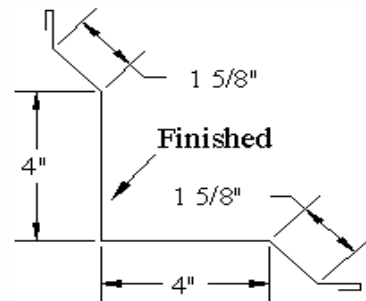

10' 6"	12' 6"	14' 3"	16' 6"	R-Panel Door Trim
RJ10	RJ40	RJ60	RJ80	Galv
RJ11	RJ41	RJ61	RJ81	White
RJ12	RJ42	RJ62	RJ82	Green
RJ13	RJ43	RJ63	RJ83	Lightstone
RJ14	RJ44	RJ64	RJ84	Taupe
RJ15	RJ45	RJ65	RJ85	Ash Gray
RJ16	RJ46	RJ66	RJ86	Ocean Blue
RJ17	RJ47	RJ67	RJ87	Tan
RJ18	RJ48	RJ68	RJ88	Charcoal Gray
RJ19	RJ49	RJ69	RJ89	Red
RJ20	RJ50	RJ70	RJ90	Brown
RJ21	RJ51	RJ71	RJ91	Black
RJ22	RJ52	RJ72	RJ92	Burgundy
RJ23	RJ53	RJ73	RJ93	Bone Wht
RJ24	RJ54	RJ74	RJ94	Antique Bronze
RJ25	RJ55	RJ75	RJ95	Hess Green
RJ26	RJ56	RJ76	RJ96	Brite Red
RJ27	RJ57	RJ77	RJ97	Dark Blue
RJ28	RJ58	RJ78	RJ98	Pewter Gray
RJ32	RJ34	RJ36	RJ38	Covert Green
RJ33	RJ35	RJ37	RJ39	Shale Green

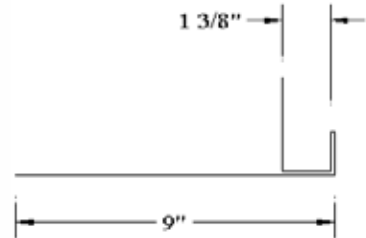

10' 6"	12' 6"	14' 6"	16' 6"
			Galv
			White
			Green
			Lightstone
			Taupe
			Ash Gray
			Ocean Blue
			Tan
			Charcoal Gray
			Red
			Brown
			Black
			Burgundy
			Bone Wht
			Antique Bronze
			Hess Green
			Brite Red
			Dark Blue
			Pewter Gray
			Covert Green
			Shale Green

Universal Ridge		Open C Channel	
UR10 Galv		OC10 Galv	
UR11 White		OC11 White	
UR12 Green		OC12 Green	
UR13 Lightstone		OC13 Lightstone	
UR14 Taupe		OC14 Taupe	
UR15 Ash Gray		OC15 Ash Gray	
UR16 Ocean Blue		OC16 Ocean Blue	
UR17 Tan		OC17 Tan	
UR18 Charcoal Gray		OC18 Charcoal Gray	
UR19 Red		OC19 Red	
UR20 Brown		OC20 Brown	
UR21 Black		OC21 Black	
UR22 Burgundy		OC22 Burgundy	
UR23 Bone Wht		OC23 Bone Wht	
UR24 Antique Bronze		OC24 Antique Bronze	
UR25 Hess Green		OC25 Hess Green	
UR26 Brite Red		OC26 Brite Red	
UR27 Dark Blue		OC27 Dark Blue	
UR28 Pewter Gray		OC28 Pewter Gray	
UR32 Covert Green		OC32 Covert Green	
UR33 Shale Green		OC33 Shale Green	

Down/spout Assembly		Outside Trim	
DS10 Galv		OA10 Galv	
DS11 White		OA11 White	
DS12 Green		OA12 Green	
DS13 Lightstone		OA13 Lightstone	
DS14 Taupe		OA14 Taupe	
DS15 Ash Gray		OA15 Ash Gray	
DS16 Ocean Blue		OA16 Ocean Blue	
DS17 Tan		OA17 Tan	
DS18 Charcoal Gray		OA18 Charcoal Gray	
DS19 Red		OA19 Red	
DS20 Brown		OA20 Brown	
DS21 Black		OA21 Black	
DS22 Burgundy		OA22 Burgundy	
DS23 Bone Wht		OA23 Bone Wht	
DS24 Antique Bronze		OA24 Antique Bronze	
DS25 Hess Green		OA25 Hess Green	
DS26 Brite Red		OA26 Brite Red	
DS27 Dark Blue		OA27 Dark Blue	
DS28 Pewter Gray		OA28 Pewter Gray	
DS32 Covert Green		OA32 Covert Green	
DS33 Shale Green		OA33 Shale Green	

Galv	Galv
White	White
Green	Green
Lightstone	Lightstone
Taupe	Taupe
Ash Gray	Ash Gray
Ocean Blue	Ocean Blue
Tan	Tan
Charcoal Gray	Charcoal Gray
Red	Red
Brown	Brown
Black	Black
Burgundy	Burgundy
Bone Wht	Bone Wht
Antique Bronze	Antique Bronze
Hess Green	Hess Green
Brite Red	Brite Red
Dark Blue	Dark Blue
Pewter Gray	Pewter Gray
Covert Green	Covert Green
Shale Green	Shale Green

Galv	Galv
White	White
Green	Green
Lightstone	Lightstone
Taupe	Taupe
Ash Gray	Ash Gray
Ocean Blue	Ocean Blue
Tan	Tan
Charcoal Gray	Charcoal Gray
Red	Red
Brown	Brown
Black	Black
Burgundy	Burgundy
Bone Wht	Bone Wht
Antique Bronze	Antique Bronze
Hess Green	Hess Green
Brite Red	Brite Red
Dark Blue	Dark Blue
Pewter Gray	Pewter Gray
Covert Green	Covert Green
Shale Green	Shale Green

Roof Edge 25 per carton 29ga

- RO13 Roof Edge Sandstone
- RO25 Roof Edge Terratone

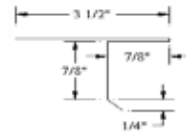

Gutter Apron 25 per carton 29ga

- GP13 Gutter Apron Sandstone
- GP25 Gutter Apron Terratone



24" x 50' Roll Flat Stock (26 Ga)

- FS11 White
- FS12 Green
- FS13 Lightstone
- FS14 Taupe
- FS15 Ash Gray
- FS16 Ocean Blue
- FS17 Tan
- FS18 Charcoal Gray
- FS19 Red
- FS20 Brown
- FS21 Black
- FS22 Burgundy
- FS23 Bone Wht
- FS24 Antique Bronze
- FS25 Hess Green
- FS66 Brite Red
- FS27 Dark Blue
- FS28 Pewter Gray
- FS29 Copper Penny
- FS32 Covert Green
- FS33 Shale Green



11-7/8" x 100' Roll Flat Stock (26 Ga)

- FS61 White
- FS62 Green
- FS63 Lightstone
- FS64 Taupe
- FS65 Ash Gray
- FS66 Ocean Blue
- FS67 Tan
- FS68 Charcoal Gray
- FS69 Red
- FS70 Brown
- FS71 Black
- FS72 Burgundy
- FS73 Bone Wht
- FS74 Antique Bronze
- FS75 Hess Green
- FS76 Brite Red
- FS77 Dark Blue
- FS78 Pewter Gray
- FS79 Copper Penny
- FS82 Covert Green
- FS83 Shale Green



Rollvalley Flashing (nominal 29ga)

- GV4 4" Galvanized Valley 50' roll
- GV6 6" Galvanized Valley 50' roll
- GV8 8" Galvanized Valley 50' roll
- GV10 10" Galvanized Valley 50' roll
- GV12 12" Galvanized Valley 50' roll
- GV14 14" Galvanized Valley 50' roll
- GV16 16" Galvanized Valley 50' roll
- GV20 20" Galvanized Valley 50' roll
- GV24 24" Galvanized Valley 50' roll
- GV28 28" Galvanized Valley 50' roll
- GV30 30" Galvanized Valley 50' roll
- GV36 36" Galvanized Valley 50' roll



Marvec PVC Liner

- TP12 Liner Panel 12' 2"
- TP16 Liner Panel 16' 2"
- TP20 Liner Panel 20' 2"

Panel thickness .032

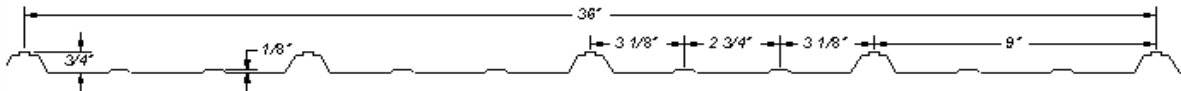

- TP30 Tuftex J Trim
- TP25 Tuftex S.S Screws # 12 x 1-1/4" 500/Bag White



Silicone

SI10	Clear Nova/Flex Metal Roofing Sealant
SI11	White Nova/Flex Metal Roofing Sealant
SI12	Green Nova/Flex Metal Roofing Sealant
SI13	Lightstone Nova/Flex Metal Roofing Sealant
SI14	Taupe Nova/Flex Metal Roofing Sealant
SI15	Ash Gray Nova/Flex Metal Roofing Sealant
SI16	Ocean Blue Nova/Flex Metal Roofing Sealant
SI17	Tan Nova/Flex Metal Roofing Sealant
SI18	Charcoal Gray Nova/Flex Metal Roofing Sealant
SI19	Red Nova/Flex Metal Roofing Sealant
SI20	Brown Nova/Flex Metal Roofing Sealant
SI21	Black Nova/Flex Metal Roofing Sealant
SI22	Burgundy Nova/Flex Metal Roofing Sealant
SI23	Bone Wht Nova/Flex Metal Roofing Sealant
SI24	Antique Bronze Nova/Flex Metal Roofing Sealant
SI25	Hess Green Nova/Flex Metal Roofing Sealant
SI26	Brite Red Nova/Flex Metal Roofing Sealant
SI27	Dark Blue Nova/Flex Metal Roofing Sealant
SI28	Pewter Gray Nova/Flex Metal Roofing Sealant
SI29	Copper Penny Nova/Flex Metal Roofing Sealant
SI33	Shale Green Nova/Flex Metal Roofing Sealant
SI40	MR150 Clear 20 fl oz Sausage Nova/Flex Metal Roof Adhesive Sealant
DS10	Dekstrip Expandable Edged Flashing 9" x 10' roll













RE2 2 - 150' RE2 Re-roof Retrofit Spacer High rolls density polyethylene foam

Soffit Nails 1-1/4" Ring Shank Stainless S

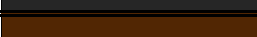
NA11	600/box 1-1/4" Soffit nails White
NA12	600/box 1-1/4" Soffit nails Green
NA13	600/box 1-1/4" Soffit nails Lightstone
NA14	600/box 1-1/4" Soffit nails Taupe
NA15	600/box 1-1/4" Soffit nails Ash Gray
NA16	600/box 1-1/4" Soffit nails Ocean Blue
NA17	600/box 1-1/4" Soffit nails Tan
NA18	600/box 1-1/4" Soffit nails Charcoal Gray
NA19	600/box 1-1/4" Soffit nails Red
NA20	600/box 1-1/4" Soffit nails Brown
NA21	600/box 1-1/4" Soffit nails Black
NA22	600/box 1-1/4" Soffit nails Burgundy
NA23	600/box 1-1/4" Soffit nails Bone Wht
NA24	600/box 1-1/4" Soffit nails Antique Bronze
NA26	600/box 1-1/4" Soffit nails Brite Red
NA27	600/box 1-1/4" Soffit nails Dark Blue
NA28	600/box 1-1/4" Soffit nails Pewter Gray
NA29	600/box 1-1/4" soffit nails Copper Penny

1" Classic Snap Lock 16" Coverage (24ga)

List Price

CS11	Classic Snap Lock 16" Coverage (24ga) 1" White	
CS12	Classic Snap Lock 16" Coverage (24ga) 1" Green	
CS14	Classic Snap Lock 16" Coverage (24ga) 1" Taupe	
CS16	Classic Snap Lock 16" Coverage (24ga) 1" Ocean Blue	
CS18	Classic Snap Lock 16" Coverage (24ga) 1" Charcaol Gray	
CS20	Classic Snap Lock 16" Coverage (24ga) 1" Brown	
CS21	Classic Snap Lock 16" Coverage (24ga) 1" Black	
CS22	Classic Snap Lock 16" Coverage (24ga) 1" Burgundy	
CS24	Classic Snap Lock 16" Coverage (24ga) 1" Antique Bronze	
CS26	Classic Snap Lock 16" Coverage (24ga) 1" Brite Red	
CS28	Classic Snap Lock 16" Coverage (24ga) 1" Pewter Gray	
CS29	Classic Snap Lock 16" Coverage (24ga) 1" Copper Penny	

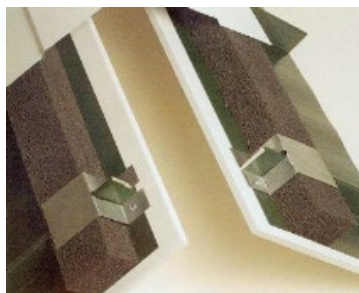
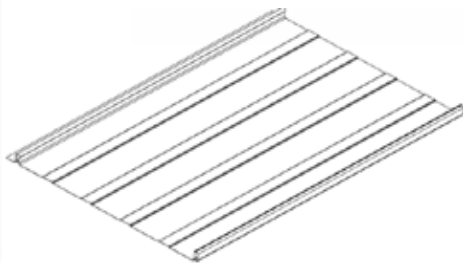

UC100 Universal Ridge Clip 1" 20 per Box

CS85 Classic Seam Snap Lock Panel 16" SV2 Closure



WS10 250/Bag 10 x 1" SQ/Phil Wafer Clip Screws

WS11 250/Bag 10 x 1-1/2" SQ/Phil Wafer Clip Screws



US15 1" x 1" Universal Expandable EM-Seal Closures 19' roll



14"	20"		14" & 20" Ridge Cap
RID10	RID40	Galv	
RID11	RID41	White	
RID12	RID42	Green	
RID13	RID43	Lightstone	
RID14	RID44	Taupe	
RID15	RID45	Ash Gray	
RID16	RID46	Ocean Blue	
RID17	RID47	Tan	
RID18	RID48	Charcoal Gray	
RID19	RID49	Red	
RID20	RID50	Brown	
RID21	RID51	Black	
RID22	RID52	Burgundy	
RID23	RID53	Bone Wht	
RID24	RID54	Antique Bronze	
RID25	RID55	Hess Green	
RID26	RID56	Brite Red	
RID27	RID57	Dark Blue	
RID28	RID58	Pewter Gray	
RID29	RID59	Copper Penny	

20"	26"		20" & 26" Valley Trim
VT10	VT40	Galv	
VT11	VT41	White	
VT12	VT42	Green	
VT13	VT43	Lightstone	
VT14	VT44	Taupe	
VT15	VT45	Ash Gray	
VT16	VT46	Ocean Blue	
VT17	VT47	Tan	
VT18	VT48	Charcoal Gray	
VT19	VT49	Red	
VT20	VT50	Brown	
VT21	VT51	Black	
VT22	VT52	Burgundy	
VT23	VT53	Bone Wht	
VT24	VT54	Antique Bronze	
VT25	VT55	Hess Green	
VT26	VT56	Brite Red	
VT27	VT57	Dark Blue	
VT28	VT58	Pewter Gray	
VT29	VT59	Copper Penny	

1"			Gable & Rake Trim	1" Snap Lock Rake Trim
SL10	GR10	Galv		
SL11	GR11	White		
SL12	GR12	Green		
SL13	GR13	Lightstone		
SL14	GR14	Taupe		
SL15	GR15	Ash Gray		
SL16	GR16	Ocean Blue		
SL17	GR17	Tan		
SL18	GR18	Charcoal Gray		
SL19	GR19	Red		
SL20	GR20	Brown		
SL21	GR21	Black		
SL22	GR22	Burgundy		
SL26	GR23	Bone Wht		
SL24	GR24	Antique Bronze		
SL25	GR25	Hess Green		
SL26	GR26	Brite Red		
SL27	GR27	Dark Blue		
SL28	GR28	Pewter Gray		
SL29	GR29	Copper Penny		

SnowTrax	Clamp		SnowTrax
SX10		Galv	
SX11	CM10	White	
SX12		Green	
SX13		Lightstone	
SX14		Taupe	
SX15		Ash Gray	
SX16		Ocean Blue	
SX17		Tan	
SX18		Charcoal Gray	
SX19		Red	
SX20		Brown	
SX21		Black	
SX22		Burgundy	
SX23		Bone Wht	
SX24		Antique Bronze	
SX25		Hess Green	
SX26		Brite Red	
SX27		Dark Blue	
SX28		Pewter Gray	
SX29		Copper Penny	

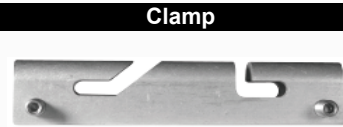

Safety

Safety is always your first consideration when installing your metal package. Hazard exist on the ground as well as on the roof.

- Always be aware of where you are on the roof. Openings, edges, electrical lines and tripping hazards (cords and equipment) are a constant danger.
- Watch electrical lines when maneuvering panels.
- Never install metal roofing on windy or stormy days. The wind can get under the panel and force you off the roof. Once the panel is loose and airborne it can become a sharp projectile.
- Roofing can be very slick when dusty, wet, or covered with frost. Avoid being on the roof when these conditions are present.
- Never step on panels until they are in place and secured with fasteners. Then only step in the flat areas and not on the panel ribs.
- Wearing soft soled shoes will help with traction while preventing scratching the panels.
- Use fall protection where needed.
- Be aware of your coworker. Make sure they are not putting themselves in danger.
- If your building has an open purlin system make sure to walk on the purlin not in between the purlin this may result in injury.

SNAP Lock Roof Maintenance



- Check roof penetrations for possible leaks. Leaks most often come from heat or air vents and skylights. Some leaks are caused by the shrinking or hardening of applied silicones as they dry out. If there is a crack or a suspected area, fill it using a Metal Roofing Sealant which is permanently flexible and won't crack.
- Inspect areas around chimneys, heat vents, oil condensers above cooking areas and air conditioners, these areas can expose your roofing to chemicals that will break down the paint system and can corrode the metal.
- Look for loose flashing, roof sheets, fasteners, or punctures from falling objects.
- Inspect your roof paint for scratches. Should this occur, clean the area with mineral spirits, rinse completely with water and allow to dry. Using paint supplied from the manufacturer of the panel apply a minimum amount of paint to cover the scratched area. This may need to be touched up again in several years.

If exposed fasteners have been used on your roof, it is imperative that they are inspected annually. The inspection entails several key points:

- Are the fasteners installed correctly? Sometimes fasteners are tightened down too much which may cause them to cut or split the neoprene washer.
- Other fasteners may not be tightened properly which will not create a seal between the fastener and the metal panel or flashing.
- Neoprene washers may break down over time due to expansion and contracting of metal panels or from exposure to ultraviolet rays. By rubbing your fingernail over the washer you will notice if it is still flexible or has hardened and is breaking apart.

Finally, look at the closures or venting materials under the ridge caps, transitions, end walls and valleys. At times this material can come loose or break down from sun exposure and cause leaks. Replace as necessary.

Preparing to Install Your New Roofing

Northland Steel & Trim quality light gauge material can be used for new or existing structures.

Prepping New Construction

1. If you need openings cut for venting through the ridge or plumbing vents or electrical conduits, now is the time to add them before panel installation.
2. It is very important to check for protruding nails and other objects which may puncture the underlayment and roofing panels. Be sure to clean all foreign materials from the roof.
3. Cover the deck with a moisture barrier such as a minimum 30 # pound felt or other approved underlayment. Begin at the eave and roll the underlayment horizontally (along the eave). Overlap the next strip at least 3 inches. (Place a hi-temp & water membrane underlayment in areas which snow, ice, and rain can accumulate, such as valleys and eaves,. This will be applied to the roof before rolling the 30 # pound felt out).
4. Place an alignment line along the gable end where the first panel will be installed. This line must be parallel to the gable edge of the roof and square with the eave edge. Check the roof for squareness by making a 3 foot line across the eave. (see illustration)
Completing the 3' x 4' x 5' triangle should place the 4' line parallel along the gable edge. The first panel will be placed along this line. Any out of square conditions up to 3" can be covered by the gable trim.

It is important to measure the roof from gable to gable. Proper placement of panels will allow the panel ribs on each side to be covered by the gable trim while creating a symmetrical appearance on the roof.

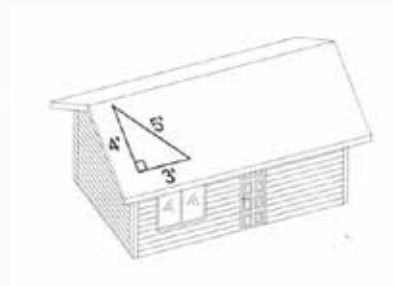

Re-roofing Existing Structures

It is best if existing roofing such as shingles, cedar shakes be removed so there is a smooth substrate for installing metal roofing panels. Metal roofing should never be installed over an uneven surface.

Another good reason for stripping a roof is to look for any defects which need repair or replacements.

Never apply metal roofing over a damaged substrate.

If you are going to strip the roof go back to new roof installation.

If you do decide to apply over existing roofing, inspect the roof for defects and repair so the new roofing has a flat surface to be applied to.

1. Secure or remove any wrapped roofing.
2. Make sure there are no protruding nails or other objects which may affect the new underlayment or roofing panels.
3. Remove all moss and other debris.
4. Remove all hip cap, ridge cap, and penetration flashing.
5. Cover the deck with a moisture barrier such as a minimum 30 # pound felt or other approved underlayment. Begin at the eave and roll the underlayment horizontally (along the eave). Overlap the next strip at least 3 inches. (Place a hi-temp & water membrane underlayment in areas which snow, ice, and rain can accumulate, such as valleys and eaves. This will be applied to the roof before rolling the 30 # pound felt out).
6. Place an alignment line along the gable end where the first panel will be installed. This line must be parallel to the gable edge of the roof and square with the eave edge. Check the roof for squareness by making a 3 foot line across the eave. (see illustration)
Completing the 3' x 4' x 5' triangle should place the 4' line parallel along the gable edge. The first panel will be placed along this line. Any out of square conditions up to 3" can be covered by the gable trim.

It is important to measure the roof from gable to gable. Proper placement of panels will allow the panel ribs on each side to be covered by the gable trim while creating a symmetrical appearance on the roof.



Panel Installation

Study the trim details in this manual before installing the panels. Pay close attention to valleys, eaves, and transitions.

Follow these basic guidelines:

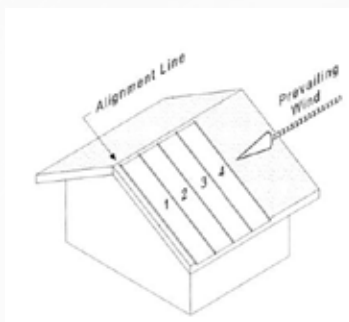
1. Install eave trim and valley trim prior to panel installation.
2. Always install your panels into the prevailing wind.
3. Align the edge of the first panel with the alignment line constructed along the gable end. Allow the panel to overhang the eave 1" to 2".
(If venting through the ridge make sure you hold the underlayment down 2" from the ridge. Also make sure your decking is 2" down from the top of the ridge on both sides. Doing this will allow for air circulation in the attic space.)
4. After the first panel is properly aligned, fasten per the fasteners placement and spacing guide.
 - A) Lay down second and third panels, check the alignment, and be sure they are square. You may have to stretch or shrink the panel by either pulling the top or bottom of the panel to make up the distance needed to be square. If you have over a 1/4" to make up it is best to stretch or shrink the panel over the next few panels.
5. After the panel are installed, you can install the rest of your trim and flashing. Start at the eave edges and work your way up. For example, place your gable trim starting at the bottom edge and work towards the ridge. If pieces must be overlapped: a 2" minimum is recommended. Once the gable trim is installed, you may then install the ridge cap. Please see trim details on how each piece of trim is to be handled.



FASTENERS		
CORRECT	TOO LOOSE	TOO TIGHT
		
EPDM MATERIAL IS COMPRESSED AND VISIBLE AT WASHER. FASTENER IS PROPERLY INSTALLED.	EPDM NOT AT VISIBLE JOINT. NOT ENOUGH COMPRESSION TO MAKE A SEAL.	FASTENER IS OVER DRIVEN AND EPDM IS PROTRUDING BEYOND EDGE OF FASTENER.

Fastener Installation

Screw fasteners have been proven to have 2 to 3 times the holding power of nails. For maximum holding power, it is recommended that the minimum wood penetration be 1 inch. Utilizing pancake head screw fasteners have an excellent quality and are specifically designed for fastening clips to the metal roofing panels. For OSB and plywood $\frac{1}{2}$ " or less, use #14 x 1" wood screws.

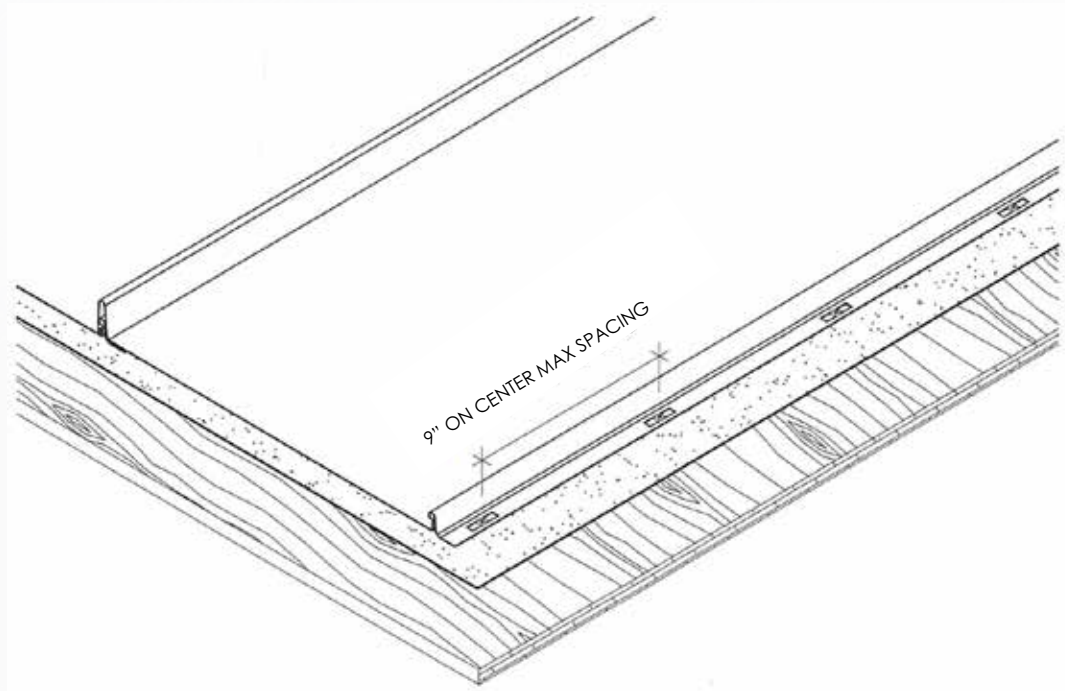

All testing based on 24ga material

To prevent damage to panels and trim, install immediately or store in a cool dry area. Carbonized steel, galvanized steel, Aluminized steel, galvalume and all alloys of aluminum are susceptible to what is commonly referred to as "white" or "black" rust and water stain. These are caused by electrolysis, which occurs when moisture exists between stacked sheets. Painted metal products are also susceptible to a change of or loss of paint gloss discoloration, delaminating, disintegrating, and other accelerated defects of the paint as a result of moisture between the panels sheets. **Northland Steel and Trim assume no responsibility of liability for damage to our product which occur in the possession of the consignee or which we deem to be improper handling and storage.** If panels are to be cut or drilled, be certain to wipe free any metal filings that may have accumulated. Protective plastic film on the trim should be removed within 90 days. **Failure to follow these instructions may void the warranty.**

SNAP Lock Panel Profile & Laps

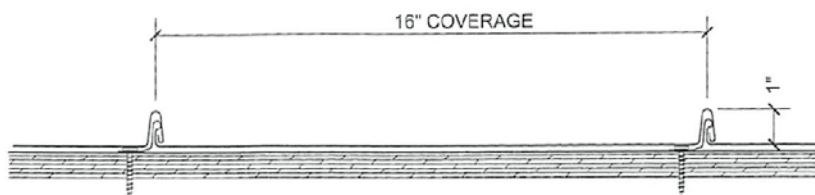

1" Panel Profile

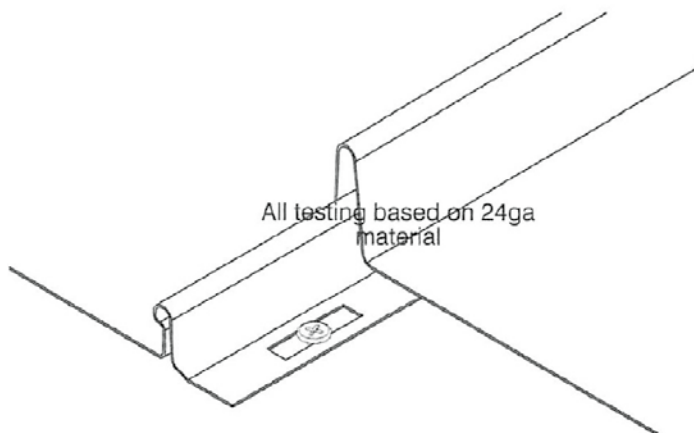

Seams

Vented Ridge Cap

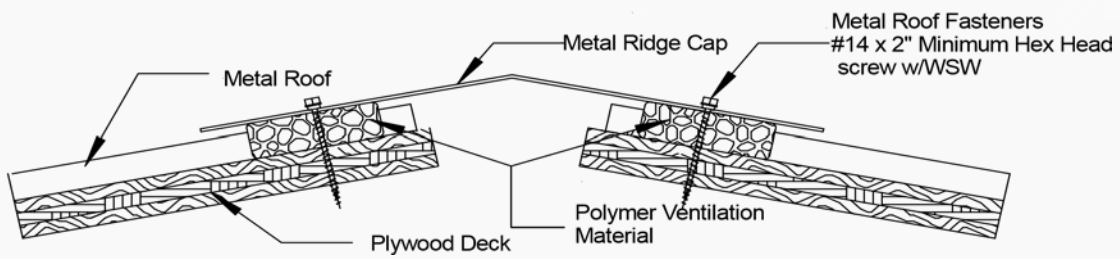
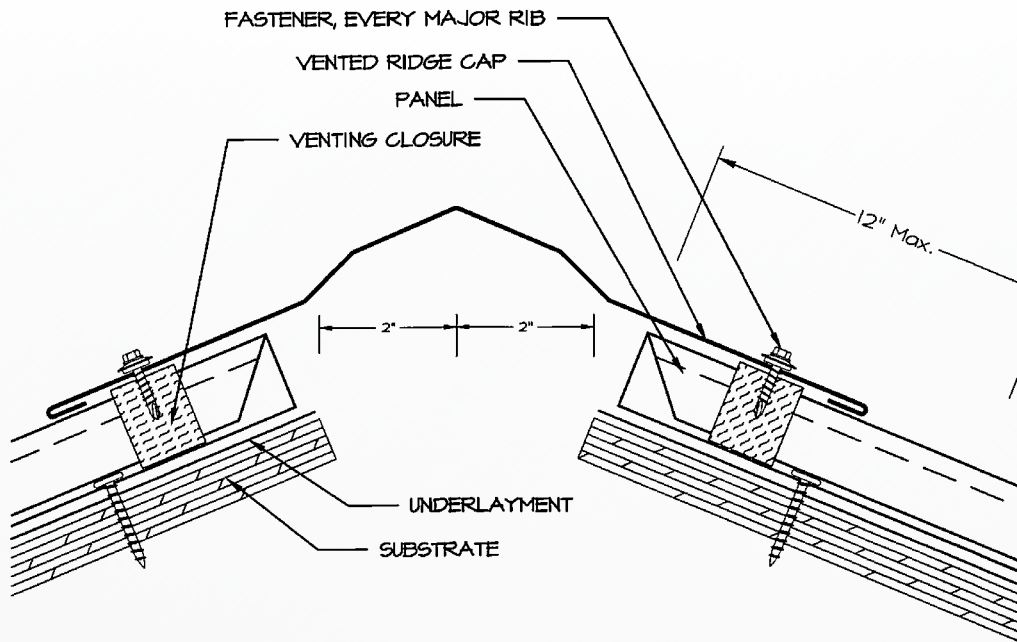

Per Metal Roof
Manufacturers Instructions
but no more than 9" o.c. maximum

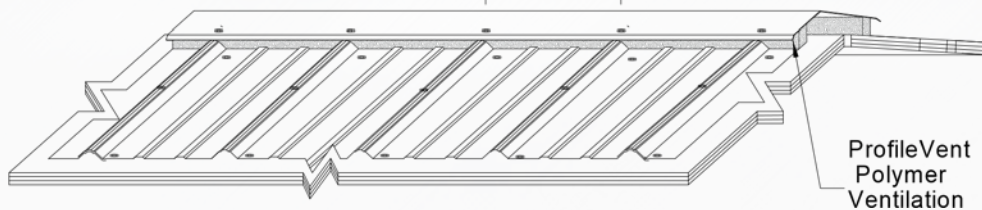

SNAP Lock Trims



F&J - Fascia Trim - Soffit - 1/2 J-Trim

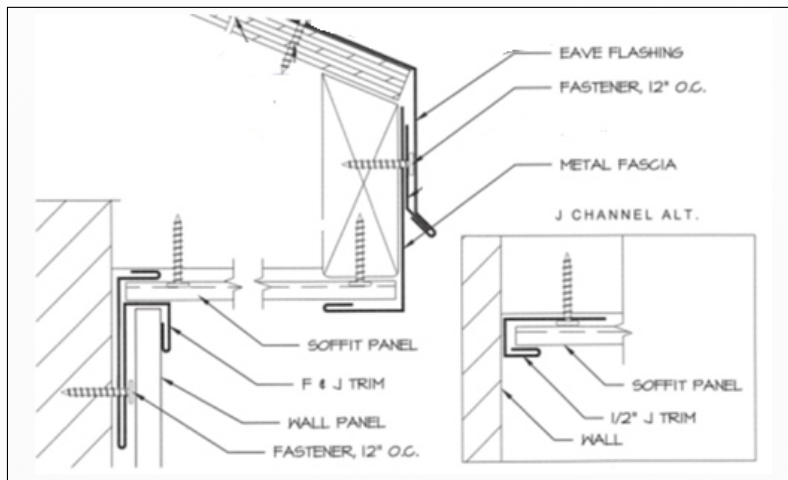

Endwall Flashing

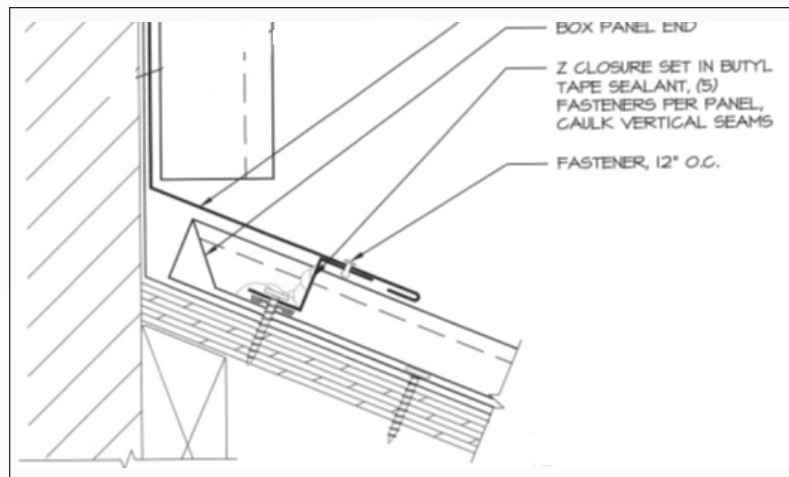

Classic Snap Lock 16" Installation Steps



1. Snap a chalk line 1" from rake edge of the roof.
2. Align the female edge of the first panel with the chalk line.
The panel should overhang the eave as required by the selected eave detail.
3. Check panel alignment. If panel is properly aligned, attach rake with a #10 x 1" hi-low woodscrew at 24" centers.

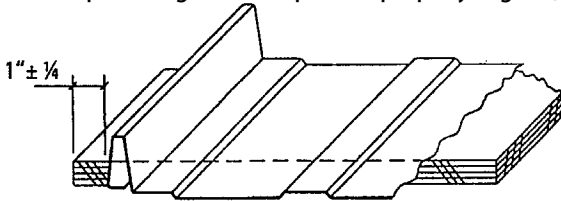

4. Attach the extended nail strip leg of the first panel to the plywood substrate with a #10 x 1" pancake head fasteners at 9" centers (alternate slots).

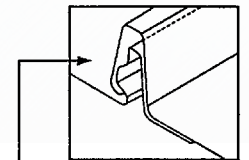
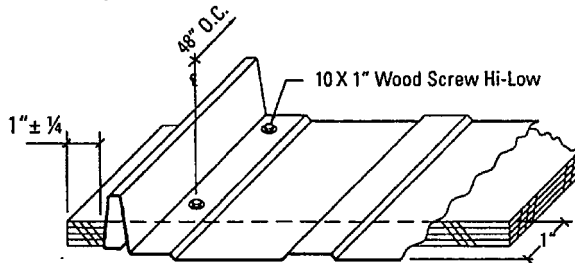

PANEL END DETAIL

FILL END WITH TUBE CAULK



5. Align the second panel female edge with the starter panel male edge.
Panels must be flush at eave edge then lightly compress and snap panels together at seam.
Snap panels from eave to ridge.

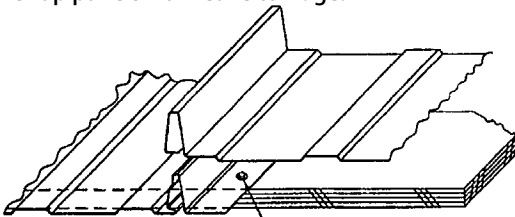

#10 - 12 X 1" Type A Pancake Head Wood Screw at 10 3/8" Centers



WS10 - 1" Wafer Screw
WS11 - 1-1/2" Wafer Screw

6. After panel seam is locked, fasten the panel with a #10 x 1" type A pancake head wood screw along the male leg at 9" on center slot.
7. Continue to apply panels as shown in the previous steps.
8. To terminate panels - fasten along the eave with a #10-11 cupped truss head wood grip with washer. Fasten along a line parallel to the eave edge 2" up from the eave edge. The fasteners are spaced at 3" centers.

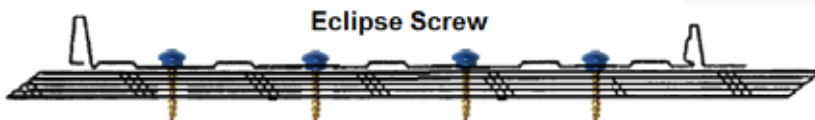

Northland
Steel & Trim

DIRECTION:

1. Begin by aligning Classic Snap Lock panel flush to the gable end of the building and attaching the flange side of the panel with pancake head screws.
2. Assemble the Rake Trim with # 10 x 1" washered screws as shown with screws 24" apart.
3. Pancake head screws should be placed 9" on center along the flange at flush depth.

Be sure fastener heads are flush with the panel flange. DO NOT OVERDRIVE SCREWS AS IT WILL INCREASE OIL CANNING IN THE PANEL. DO NOT UNDER DRIVE SCREWS OR THEY WILL LEAVE BUMPS ON THE SNAP LOCK EDGE.

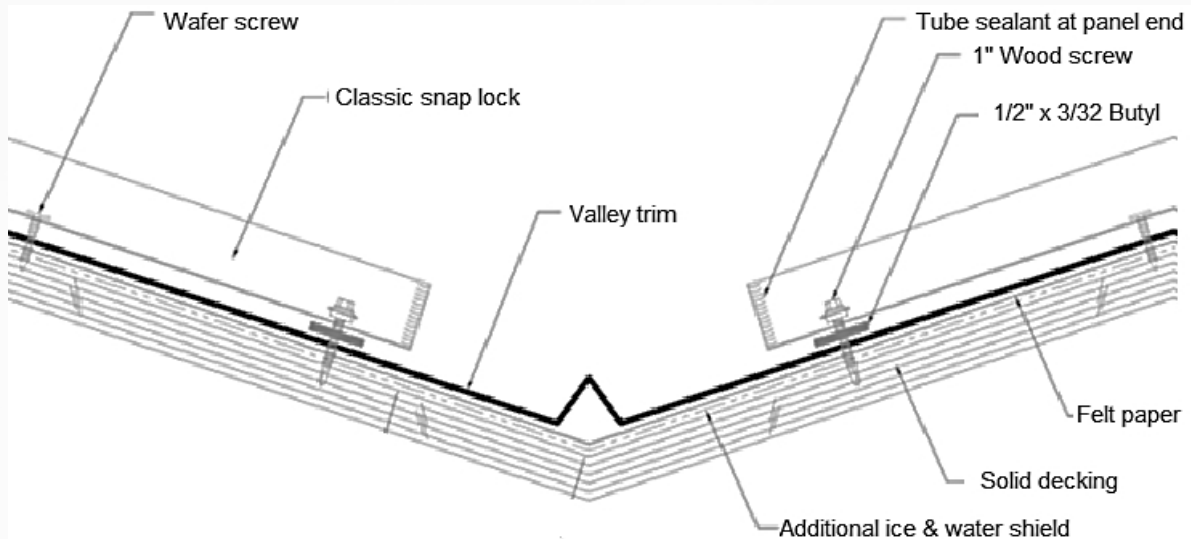
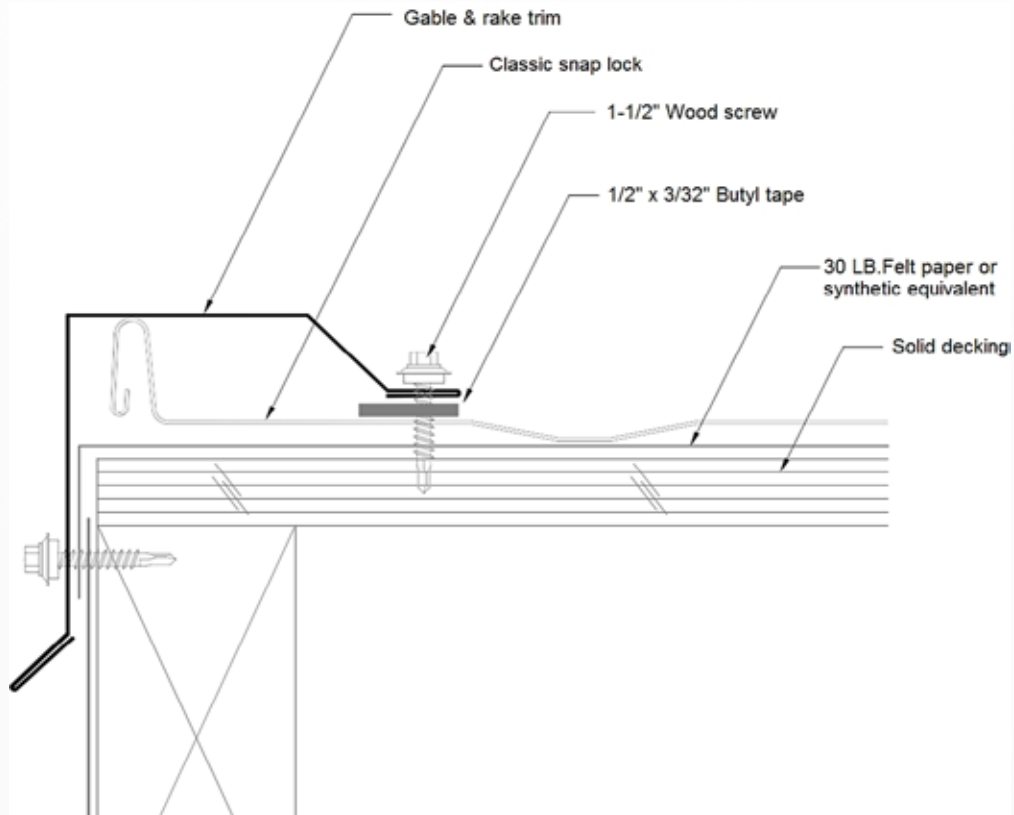

INSTALLATION INSTRUCTIONS

Universal Ridge Clip

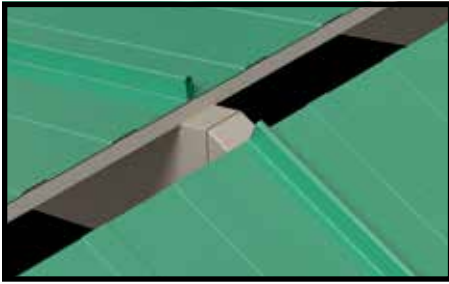

1. Allow a 2" wide continuous opening at the ridge of the building.

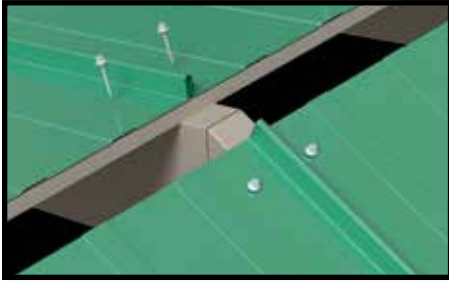

2. Fasten the top of the panel per the manufacturers recommendations.

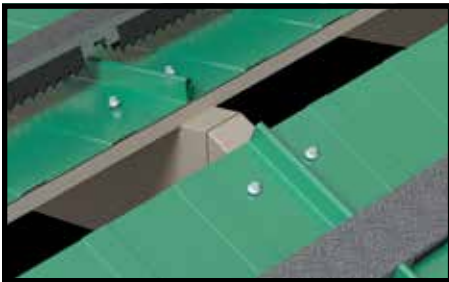

3. Position the closure on the panel so that the "down hill" edge will be covered by the ridge cap by 1/2".

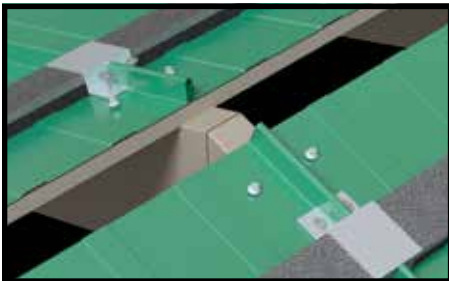

4. Fasten universal ridge clip to the panel with 1-1/4" x #10 screws.

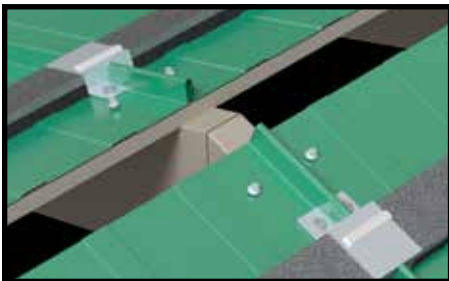

5. Caulk where clip meets the seam and on fastening area of clip.

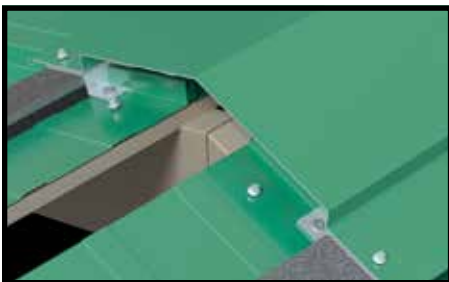

6. Fasten ridge cap to each universal ridge clip. The self drilling screws should be per manufacturers recommendations. (Fasteners are not provided.)

Classic Snap Lock Trim & Accessories

Ridge Caps – 14" and 20" 10' 6"

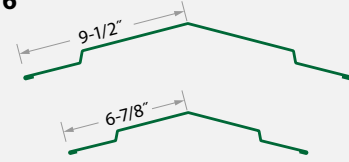

Valley Trim – 20" and 26"

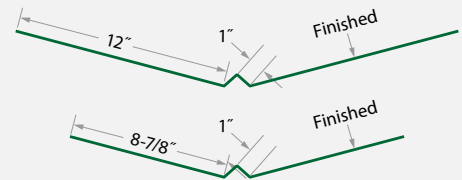

Gutter Apron and Valley Cover



1" Snap Lock Rake Trim

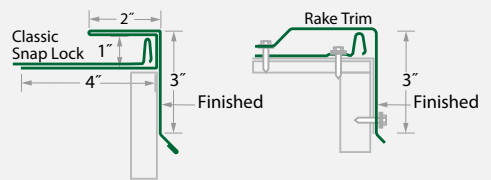

Universal Ridge Clip 1" 20 per Box

SV2 Standing Seam Closure



10 x 1" SQ/Phil Wafer Clip Screws
10 x 1/2" SQ/Phil Wafer Clip Screws
250 per Bag



1" x 1" Universal Expandable EM-Seal Closures
19' Rolls



9262 93rd Ave SE
Fullerton, ND 58441-9774
Phone: 877-862-4571 • Fax: 866-678-2823

NORTHLAND STEEL & TRIM

MRC
SnowTrax™



Putting the Clamps on Snow

*Bend Your Own Rail From Your **Color Matched** Roof Material*

ST FASTENING SYSTEMS introduces a functional but aesthetic way to prevent snow & ice dams from building up on standing seam metal roofs. The MRC SNOW TRAX incorporates a roof clamp & rail system that is easy to install & blends well into the color scheme of the roof panel. The panel manufacturer will form the rail from trim stock & slide it through the clamp to complete the system. It is functional & cost effective.



The extruded aluminum clamp & painted 26 gauge metal rail combine to form the MRC SNOW TRAX system

SnowTrax™ Available For Exposed Fastener Metal Panels



304 Stainless Steel snow guard is available in 28 powder coated industry standard colors. Use with the WOODBINDER MB micro-bit for a secure attachment to metal roof panels.

FEATURES AND BENEFITS

- Made in USA
- Colored rail bent out of customer inventory
- Freight savings
- Efficient inventory management
- Product testing independently verified
- 25 Year Warranty

The MRC SNOW TRAX standing seam roof clamp system has been designed to provide the highest degree of safety.

The extruded aluminum clamp is attached to the roof panel rib by tightening two 5/32" stainless steel cone set screws. They should be set at 70-90 inch pounds of torque. The cone shape of the point will not penetrate the seam. This will ensure the weather tightness & protect the finish on the roof panel. The clamp & rail system is designed to provide excellent holding strength.

The 25 year written warranty ensures that the MRC SNOW TRAX is free of material defects, & will provide a safe & maintenance free snow retention system.

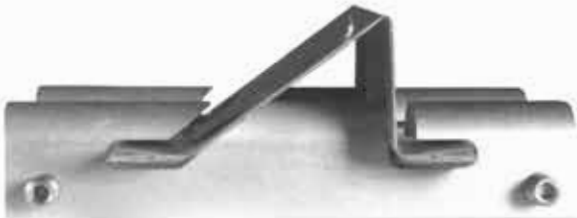

TABLE 1 - TEST RESULTS FOR MRC SNOW TRAX

Ultimate Axial Load Capacity - 26 gauge steel roof panel	913 lbf [S.D. 46.6 lbf]
Ultimate Axial Load Capacity - 24 gauge steel roof panel	843 lbf [S.D. 67.4 lbf]
Ultimate Axial Load Capacity - All Samples	878 lbf [S.D. 64.7 lbf]

MRC SnowTrax™



The Extruded Aluminum alloy clamp is machined with pre-drilled holes. 26 gauge colored rail is formed to slide through the grooves in the clamp.



304 Stainless Steel coned set screws are provided to secure the clamp to the standing seam roof panel.

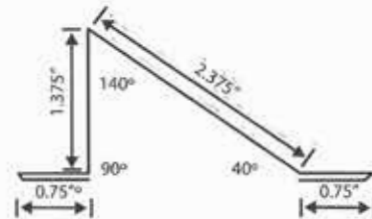

The schematic drawing below illustrates the dimensions to fabricate the rail from the same material as the roof.

APPLICATIONS

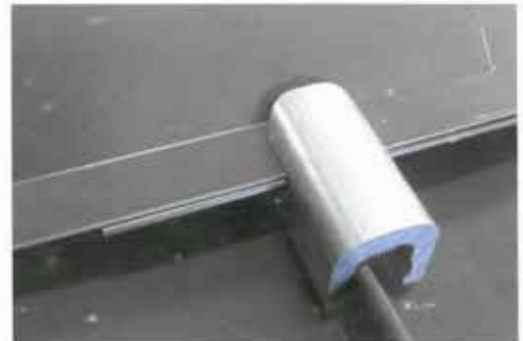

The MRC SNOW TRAX is shown installed with the colored rail.



The MRC SNOW TRAX is both functional & attractive. The colored rail blends into the overall look of the roof panel.

Northland

Steel & Trim

2019

Phone 877-862-4571

Weekly Delivery Schedule

Fax 866-678-2823

Monday Delivery		Wednesday		Friday Delivery	
Orders submitted by the previous Thursday at 5:00 pm		Orders submitted by the previous Friday at 5:00 pm		Orders submitted by the previous Tuesday at 9:00 A:M	
North Dakota	Minnesota	North Dakota	South Dakota	South Dakota	Minnesota
Casselton	Ada	Anamoose	Aberdeen	Plankinton	Adrian
Cooperstown	Alexandria	Ashley	Arlington	Platte	Beaver Creek
Drayton	Appleton	Beach	Avon	Redfield	Brewster
Enderlin	Argyle	Beulah	Beresford	Roscoe	Clements
Fairmount	Ashby	Bismarck	Bowdle	Salem	Comfrey
Fargo	Barnesville	Bottineau	Brookings	Sioux Falls	Edgerton
Finley	Benson	Bowman	Bryant	Stickney	Fairmont
Forman	Canby	Cando	Canova	Timber lake	Fulda
Grafton	Chokio	Carrington	Canton	Tripp	Hendricks
Grand Forks	Clara City	Carson	Chamberlain	Vermillion	Heron Lake
Gwinner	Crookston	Crosby	Clark	Wagner	Jackson
Hillsboro	Danube	Devils Lake	Colman	Wessington	Jasper
Hope	Dawson	Dickinson	Colton	Wessington Springs	Lake Benton
Langdon	Detroit Lakes	Dunseith	Corsica	Willow Lake	Lake Benton
Lidgerwood	Elbow Lake	Elgin	Dell Rapids	Woonsocket	Lakefield
Lisbon	Evansville	Esmond	Desmet	Yankton	Lamberton
Mayville	Fergus Falls	Flasher	Dimock	Wilmont	Leota
McVile	Fertile	Garrison	Elkton		Lismore
Page	Frazee	Glen Ullin	Estelline		Luverne
Tolna	Glenwood	Golva	Ethan		Marshall
Valley City	Gonvick	Harvey	Eureka		Minneota
Wahpeton	Granite Falls	Hazelton	Fairfax		Morgan
Wimbledon	Greenbush	Hazen	Faulton		Pipestone
	Gully	Hettinger	Fort Pierre	Iowa	Redwood Falls
	Hawley	Jamestown	Gettysburg	Boyden	Sanborn
South Dakota	Hazel Run	Kenmare	Gregory	Cherokee	St. James
Bristol	Hector	Killdeer	Hartford	Doon	Tracy
Britton	Henning	Linton	Herreid	Estherville	Truman
Caselwood	Herman	Minot	Highmore	George	Wabasso
Clear Lake	Hoffman	Mott	Howard	Hartley	Windom
Eden	Hendricks	Napoleon	Humboldt	Hawarden	Worthington
Groton	Miltona	New Rockford	Huron	Hospers	
Holmquist	Morris	New Salem	Ipswich	Inwood	
Langford	Osakis	New Town	Kimball	Larchwood	
Milbank	Oslo	Parshall	Lake Andes	Little Rock	
Peever	Ottertail	Powers Lake	Lake Norden	Ocheyedan	
Rosholt	Park Rapids	Rolla	Leola	Orange City	
Sisseton	Parkers Prairie	Rugby	Lesterville	Paullina	
Watertown	Pelican Rapids	Stanley	Madison	Primghar	
Webster	Perham	Strasburg	Marion	Rock Rapids	
Wilmot	Red Lake Falls	Tappen	Menno	Rock Valley	
	Sauk Center	Underwood	Miller	Sanborn	
	Stephen	Washburn	Mitchell	Sheldon	
	Thief River Falls	Watford City	Mobridge	Sibley	
	Ulen	Williston	Onida	Sioux Center	
	Vergas	Wishek	Parker	Spencer	
	Wabon		Parkston	Sutherland	
	Wadena		Pierre		
	Willmar		Peever		

